

# Net-zero buildings

Halving construction emissions today



## Contents

**Foreword** | 3

**Executive summary** | 6

① **Introduction** | 10

② **Key high impact carbon reduction strategies** | 16

③ **Building layers** | 25

3.1 Structure (sub-structure and super-structure) | 27

3.2 Skin (façade) | 41

3.3 Space plan | 56

3.4 Services | 62

3.5 Stuff | 72

④ **Conclusion** | 73

# Foreword

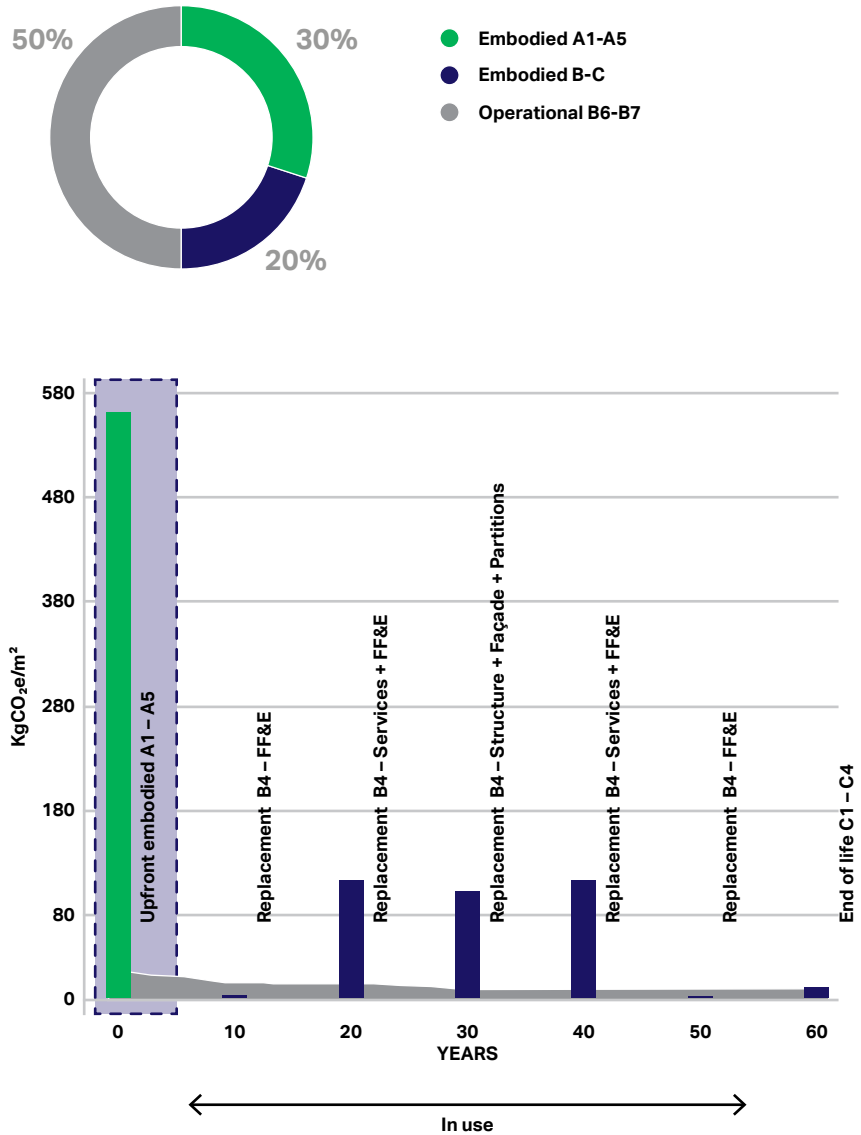
**This report builds on our previous net-zero buildings work and aims to provide insight into potential strategies and measures that companies might deploy to halve embodied carbon emissions, those associated with building components, by 2030.**

As demonstrated in the previous **Net-zero buildings: Where do we stand?** report<sup>1</sup>, as buildings generally become more energy efficient, in some cases embodied carbon already accounts for more than 50% of a new project's whole life carbon footprint. Importantly, a major component of this embodied carbon is the **upfront carbon** associated with the initial construction process and hence reaching the atmosphere at the very outset (figure 1). Although some of these carbon emissions are currently considered hard to abate, we can, and we must, aim higher and immediately develop buildings with significantly less embodied carbon if the sector is to achieve the overall net-zero targets we strive for.

In the **Where do we stand?** report, we point to **what** we need to do. The aim here is to point out strategies that will highlight the possibilities of **how** we achieve the systemic changes we require.

Time is running out, so it is essential to work with what is available today, without over-relying on major future technological advances. We must rethink the way we do things, questioning everything and adapting current practices under the lens of major reduction potential. We must prioritize consumption reduction as a first principle – doing **more with less**.

**Figure 1:** Estimated distribution of carbon emissions from *Where do we stand?* report<sup>1</sup>



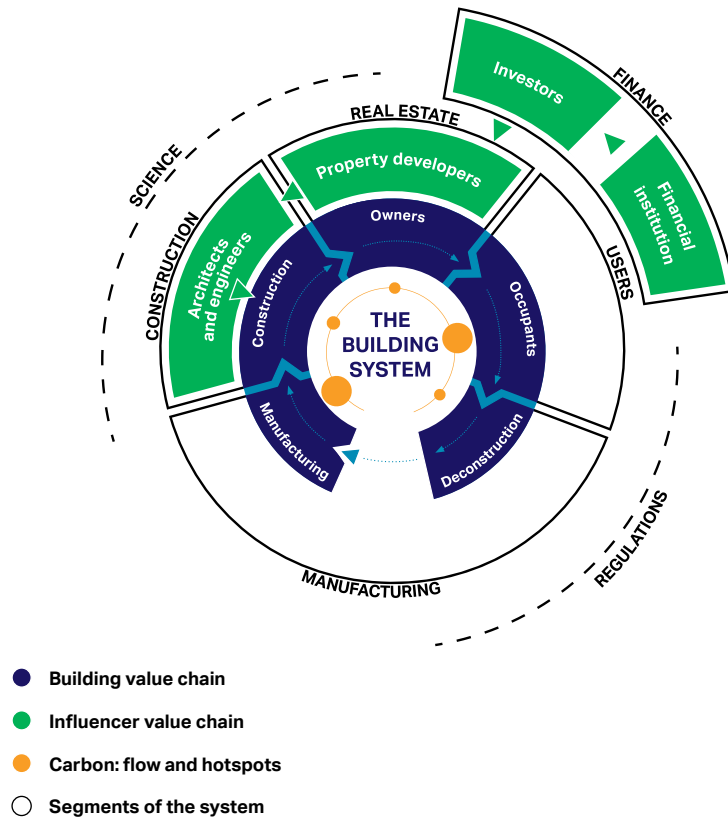
We must all fully commit to making decarbonization of our buildings an absolute and clear priority on all new projects, working together across the value chain from the outset to make this happen. We hope that this report contributes to showing that when we are properly informed, motivated, and working in a

singular collaborative environment from the very outset, we can already do significantly better than the current outcomes we are achieving.

The building industry is not the same, or as advanced, in all parts of the world and we must recognize this while still driving toward the overall objective in terms of global emissions reductions. The mantra of doing **more with less** is valid in all geographies. We must also recognize that in the immediate timeframe of the next decade, some more advanced parts of the industry will need to achieve beyond the advocated halving of emissions in order to achieve the change required globally. To succeed, we need to set our ambitions high.

There are many barriers and competing agendas to achieving the immediate and systemic changes necessary – yet, there are also untapped opportunities. We must radically collaborate as an industry and act as one to genuinely establish the principles set out in this report.

**Figure 2:** Building and construction system value chains<sup>8</sup>



**Roland Hunziker**  
Director, Built Environment,  
WBCSD

“We need and we can halve the emissions in the built environment by 2030. This report highlights the importance of radical collaboration across the entire value chain to achieve this goal. We identify practical and holistic measures that can be deployed in any building project around the world now – because 2030 is today.”



**Chris Carroll**  
Building Engineering Director,  
Arup

“To meet the immense global decarbonization challenge our industry faces, we need to immediately halve our consumption-based emissions. To achieve this goal, we must galvanize the whole of our historically fragmented and slow to innovate value chain and support it with appropriate levels of governmental legislation.”

In developing this report, we have engaged with a wide number of WBCSD members, representative of the full built environment value chain (figure 2), to explore practical, implementable strategies that we can deploy now to gain significant upfront carbon reductions. We look forward to the expansion of this work to explore in increasing detail how we can drive the rapid, widescale decarbonization of the whole built environment.

Based on this work, we call on companies throughout the built environment and worldwide to implement systemic, not incremental, changes to achieve the shared goal of at least halving our emissions by 2030. We need this systemic change today, as we are already planning what will be built in 2030. **For the built environment, 2030 is today.**

## **For the built environment, 2030 is today**

**It is possible to at least halve embodied carbon emissions immediately by using what is already available. But there is no single solution. Business leaders must put every decision they make under the spotlight of the goal to halve emissions and make well-informed choices that create genuine large-scale whole life carbon reductions. This report indicates strategies that, combined thoughtfully, should give the confidence to act to achieve this goal now. The world is facing a global crisis that requires urgency and immediate concerted action. Carbon must become a priority, equal to money in future decision-making.**



# Executive summary

This report is a follow-up to the WBCSD **Net-zero buildings: Where do we stand?**<sup>1</sup> publication which provided a detailed description of how to account for full life-cycle emissions of building projects based on six whole life carbon assessments (WLCA). That report framed the challenge in terms of the dramatic decarbonization of the built environment. This **Net-zero buildings: Halving construction emissions today** report points to **how** to do it in relation to the systemic change requirements identified previously.

This report focuses on embodied carbon as this is proving challenging to abate globally and represents an immediate

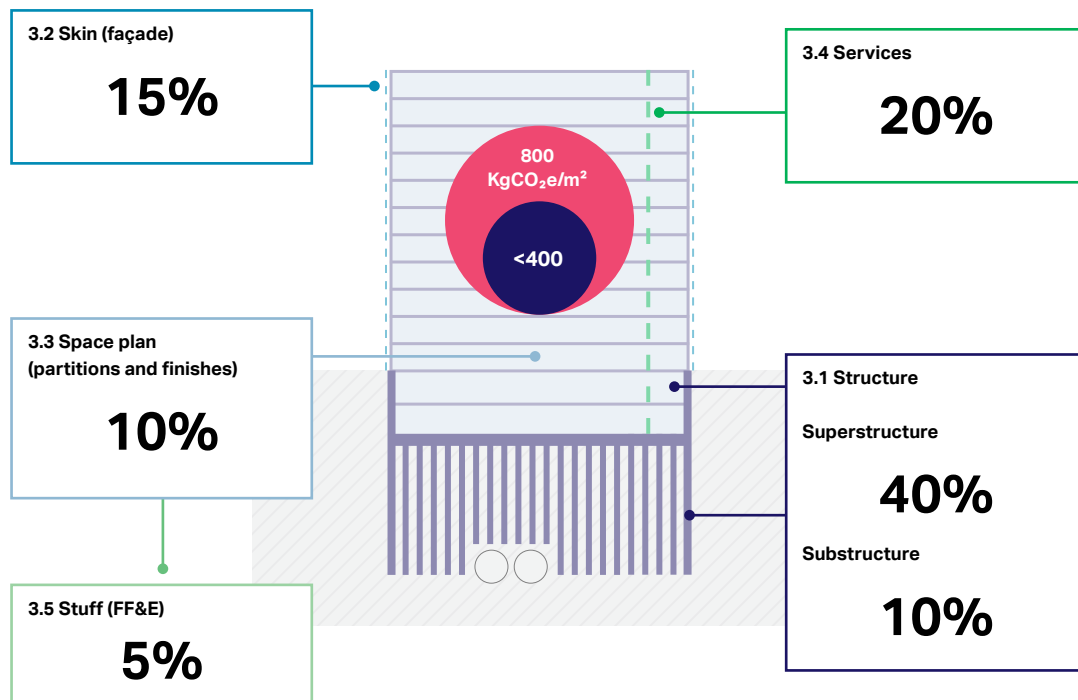
concern over the next decade, a period in which companies need to significantly increase their efforts to stay on track toward a net-zero future. In this work, we focus on upfront embodied carbon as this represents a clear challenge in terms of reductions targeting the goals associated with 2030. However, we also point to reduction strategies associated with life-cycle embodied carbon and we touch on the impact of operational carbon, which will be a specific focus in our next report in the **Net-zero buildings** series, on the inter-relationship between embodied and operational carbon.

We ask, **how do we halve?** the current construction emissions of building projects by using

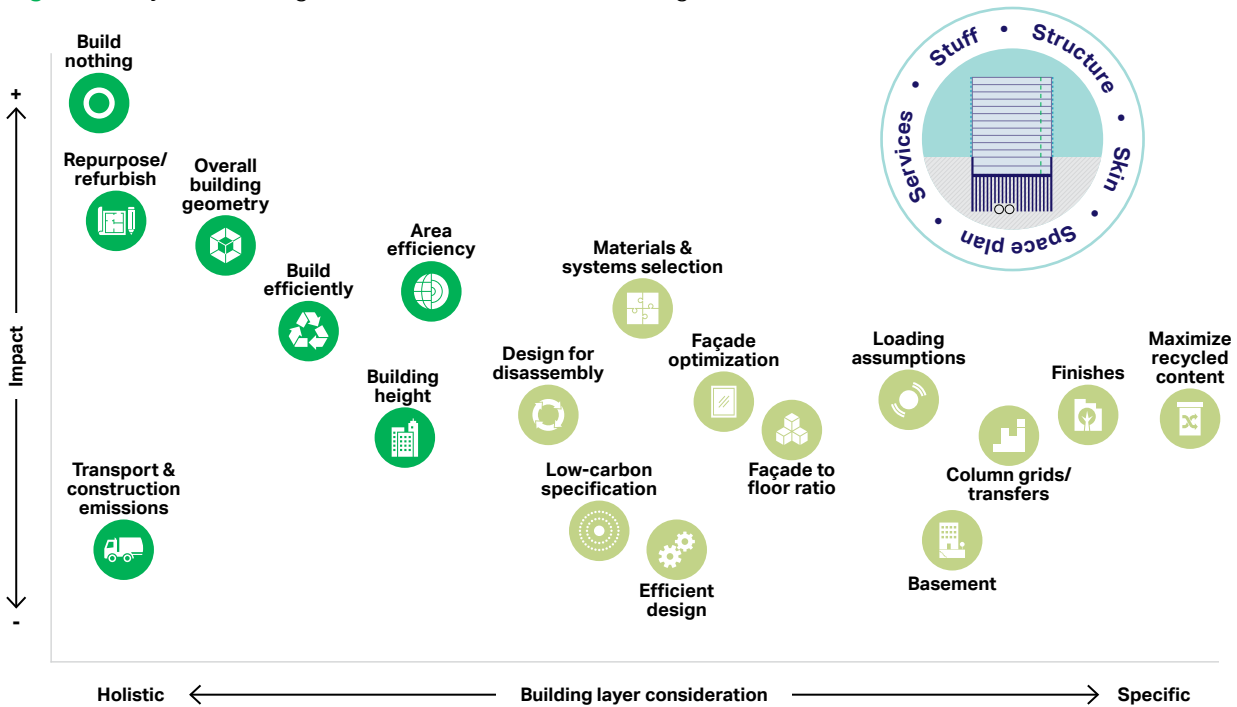
and adapting currently available technology, materials, and products. Reducing emissions as much as possible will require a focus on **all aspects of a building**, from the **earliest possible moment**, by all players in the value chain.

There is **no “silver bullet”** and we do not intend for the report to be definitive but to raise awareness of the potential to achieve the significant reductions in carbon levels we can and must make. We aim to provide insight into strategies that, when brought together under the prioritized objective of driving carbon reductions, can begin to frame the possibility of how to at least halve current embodied carbon emissions.

**Figure 3:** Upfront embodied carbon estimated (A1-A5)



**Figure 4:** Key overarching considerations – whole-building decisions

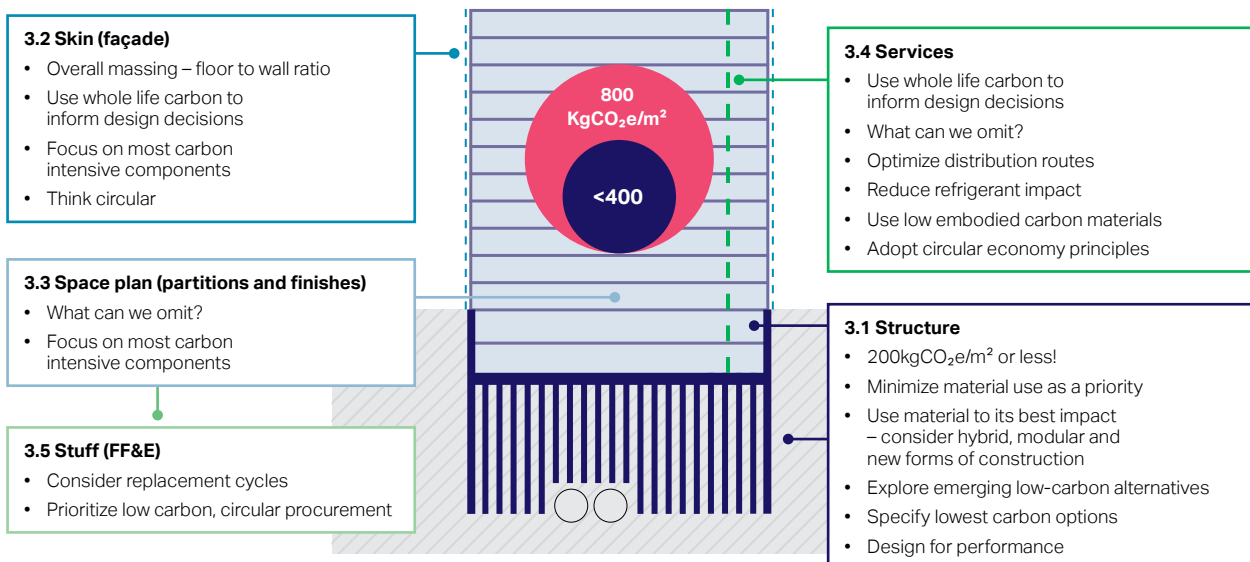


The first part of the report explores the impact of early-stage, whole-building decisions, and the major impact these can have on the carbon outcome of a particular project (**section 2**). For example, the decisions whether to build, what to build, what to re-purpose, and general building massing on a site might have a significant impact on the overall carbon outcome of a particular project (figure 4).

The second part looks in more detail at the specific decisions and measures we might take within the individual building layers to maximize the reductions we can achieve (**section 3**). Gains at the individual building layer level (figure 5) may often seem insignificant in isolation, but when taken together across all the building layers, they may aggregate to major reductions.

The report points to the importance of looking at every project, and all the decisions behind it, through the lenses of both the whole building and the individual buildings layers, to achieve the best possible carbon reduction outcomes. There are many parallels with how projects are assessed commercially, and we urge companies to now consider carbon with the same rigor that is applied to cost.

**Figure 5:** Examples of building layer specific decisions



## Key outcomes and messages

The urgency and need to prioritize carbon should be a given. It is necessary to consider carbon as part of the new economics of all projects, an equal to money. Carbon accounting must be a transparent metric shaping all future projects. Given the urgency, business must fully support this prioritization and appropriate levels of supportive legislation must drive it.

Looking at the impact of key early decisions, such as what companies build and how they shape their briefs, an appropriate understanding of carbon impacts must drive the inception of all projects. Typically, architecture, engineering and construction (AEC) firms achieve the biggest impacts at the earliest stage of their projects. That is not to say we should not then try to squeeze everything we can in

relation to carbon reduction out of all stages, as every reduction counts. To make substantiated reductions in carbon emissions, companies must be scientific in their scrutiny of the numbers, and firms must collect, share, and analyze data rigorously. Industry players must review decisions systemically across multiple inter-related parameters and evaluate the notion of carbon payback in reaching the right balanced solution across operational and embodied carbon.

Genuine atmospheric carbon emissions reductions must be our goal. To be genuine projects should prioritize the general use of less resources over a reliance on a disproportionate share of scarce lower carbon resources. We must focus on the immediate potential big wins at scale and not get distracted by incidental reduction potential.

It should seem obvious, but we point out that, generally, if the industry consumes fewer resources in delivering the same outcome, it lowers its carbon footprint in proportion to this reduction. Hence, we identify as a clear outcome throughout the report the prioritization of **using less**. Aligned with this, a transition to a circular economy will clearly play a part in decarbonizing future building projects. Looking for the highest possible reuse value of everything from whole buildings to the systems and components within them will be a key part of using fewer resources, avoiding waste and the need to keep expending embodied carbon during the life cycles of buildings.



Arup – Central Saint Giles



## Key points to take from the report

- **Data is key** and will drive informed calculation, analysis, and consistent reporting as an enabler of the highest impact.
- Companies must quickly gain the confidence to **treat carbon like money**, setting clear budgetary targets.
- **Early well-informed thinking** is essential to gain the highest reduction potential.
- A **systemic approach** is required as there is no single solution.
- **Collaborative** engagement of the entire value chain is the only way we will gain the required reductions.
- **Urgent** and decisive action is essential as for the built environment **2030 is today**.

**With this report we call on all built environment companies throughout the entire value chain to come together around an agreed set of decisive actions.**

## Actions to take today

	Action	Outcome
<b>Urgent &amp; collaborative</b>	Immediate concerted action to adopt whole life carbon (WLC) measurement and reductions as standard practice within the industry. All actors must collect, analyze, transparently report and <b>openly share data</b> on all projects.	Design, planning and investment decisions, including value engineering made on the basis of <b>carbon as cost</b> .
<b>Early</b>	Informed consideration of WLC at the outset of all new or refurbishment projects including all building elements/ systems to determine strategic design decisions and procurement strategy.	Increased potential to realize significant carbon reductions on individual assets.
<b>Systemic</b>	Adopting consistent data across all layers of a building to support resource reductions and the transition of the supply chain, addressing global supply limitations for low-carbon and recycled alternatives to steel and concrete, bio-materials and waste products.	Genuine pathways for net-zero building transition that are aligned with science-based targets (SBTs).
<b>Circular</b>	Maximize the highest level of reuse; minimize waste, limit life cycle replacement and reuse materials and components, and adopt products with the lowest carbon.	Markets created for product-as-a-service; new and recycled materials

# 1 Introduction

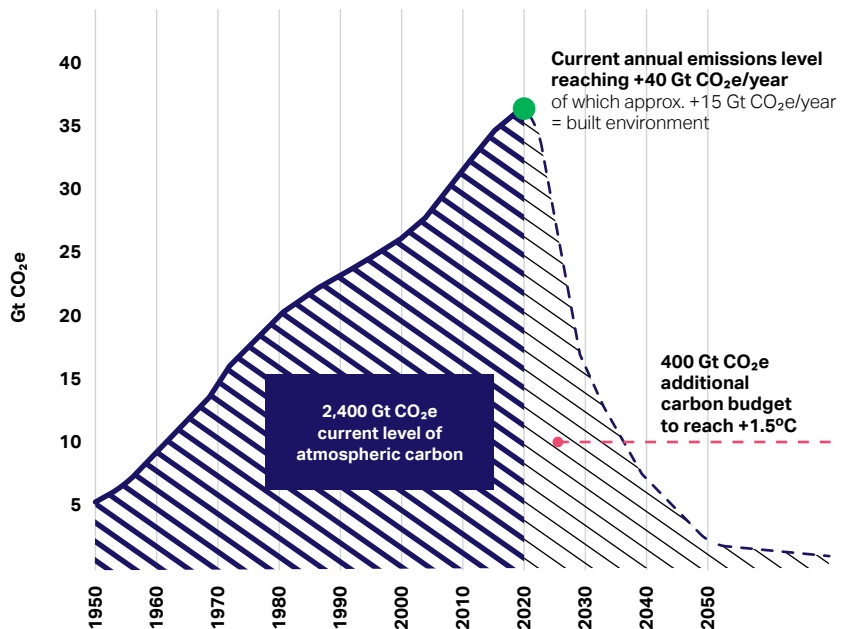
**Decarbonization trajectories in line with the 1.5 °C Paris Agreement<sup>2</sup> aim to halve global carbon emissions by 2030 and reach net-zero emissions by 2050. The United Nations backed Marrakech Partnership for Global Climate Action<sup>3</sup> in its climate action pathway echoes the need for the built environment to halve emissions by 2030. Part of this goal is to reduce embodied carbon by at least 40% overall and for leading projects to achieve a reduction of at least 50%.<sup>4</sup> It is imperative to hit these challenging 2030 goals to achieve a fully net-zero built environment across the whole life cycle by 2050 at the latest.**

The built environment is a critical sector to decarbonize as it represents close to 40% of global, energy related carbon emissions – approximately 14 gigatons of carbon each year.<sup>5</sup>

Understanding the whole life carbon emissions of buildings is a key step in meaningfully creating reductions and credible pathways toward net-zero emissions. Businesses need to more accurately understand where the industry is, where it wants to get to and, importantly, how to get there. Following the publication of our **Building System Carbon Framework** (July 2020) and the **Net-zero buildings: Where do we stand?** report (July 2021), we now aim to address the last of these questions: How to at least halve emissions by 2030.

The **Net-zero buildings: Where do we stand?** report shows that around 50% of whole life carbon emissions of new building projects stem from embodied carbon. Although it is necessary

**Figure 6:** Past carbon emissions and remaining budget<sup>2</sup>



Sources:  
Intergovernmental Panel on Climate Change (IPCC)<sup>6</sup> and  
Global Alliance for Buildings and Construction<sup>7</sup>

to consider carbon emissions holistically in a whole life-cycle context, operational energy consumption has been the focus of consumption reduction measures and legislation for some time. Embodied carbon has only more recently started being part of the net-zero focus.

As seen in our previous report, most of the embodied carbon is emitted upfront at construction stages A1-A5 (figure 8). A1-A3 are product stages, including raw material supply, transport, and manufacturing; A4-A5 are construction process stages, including transport to building site and installation in the building. Therefore, in this report we focus on promoting reduction measures for these upfront stages. Operational emissions reductions

remain important, and we plan to focus specifically on this area of the net-zero agenda in our next **Net-zero buildings** publication.

The need for more clearly defined targets for upfront embodied carbon thresholds, associated with a genuine industry commitment to supporting global and national net-zero pathways, is clear. Given where things stand currently, the industry needs to achieve the deepest reductions in carbon emissions possible by using and adapting the technology, materials, and products currently available. In the short term, leaders cannot rely on the emergence of radically new technology within the next decade and must therefore support the level of reductions aimed for by adapting thinking via a prioritized focus on carbon.

Crucially, leaders must think systemically and not rely on modest incremental or superficial change to get the immediate and deep reduction levels needed.

Companies must ensure emissions reductions claimed at a building level genuinely manifest themselves as a contribution to global atmospheric carbon reductions and are not merely a localized over-reliance on using an inequitable and disproportionate amount of a particular rare low-carbon resource. Prioritizing consumption reductions should always be a primary objective before looking to use an equitable share of resources, such as cement replacements and recycled steel, for example.

With this report, we look to support the notion that leaders can and must be much bolder and more impactful in terms of reducing the construction-stage embodied carbon emissions associated with projects. But to do this, companies must be fully committed to and focused on prioritizing carbon reductions. Firms must be holistic and rigorous about accounting for the carbon impact of every decision made and be prepared to think differently and not rely on – but continually challenge – precedents.

There is not a single answer or “silver bullet” to get the halving needed. In undertaking this work, we aim to play a part in helping engender more creative,

productive, and impactful upfront dialogue between multiple parties in the value chain at the earliest stages of projects. This dialogue should focus on many of the strategies we outline in the subsequent chapters and that, when brought together, can make the deep reductions needed. Typically, companies can achieve the biggest impact in terms of construction-stage embodied carbon reductions by setting projects off in the right direction at the earliest possible opportunity. In many cases, buildings that will emit upfront construction carbon emissions in 2030 are already being designed.

**Figure 7:** WBCSD – focus on net-zero buildings



## Our approach

In 2020, we published the **Building System Carbon Framework (BSCF)**<sup>8</sup> to provide a simple approach to transparently allocate and report carbon emissions of buildings using a common metric and a whole life approach, enabling each user to identify the best emissions-reduction strategies for their part of the value chain and allowing stakeholders to make informed decisions based on clear and transparent information and a common language.

In 2021, WBCSD and Arup published the **Net-zero buildings: Where do we stand?** report<sup>1</sup>

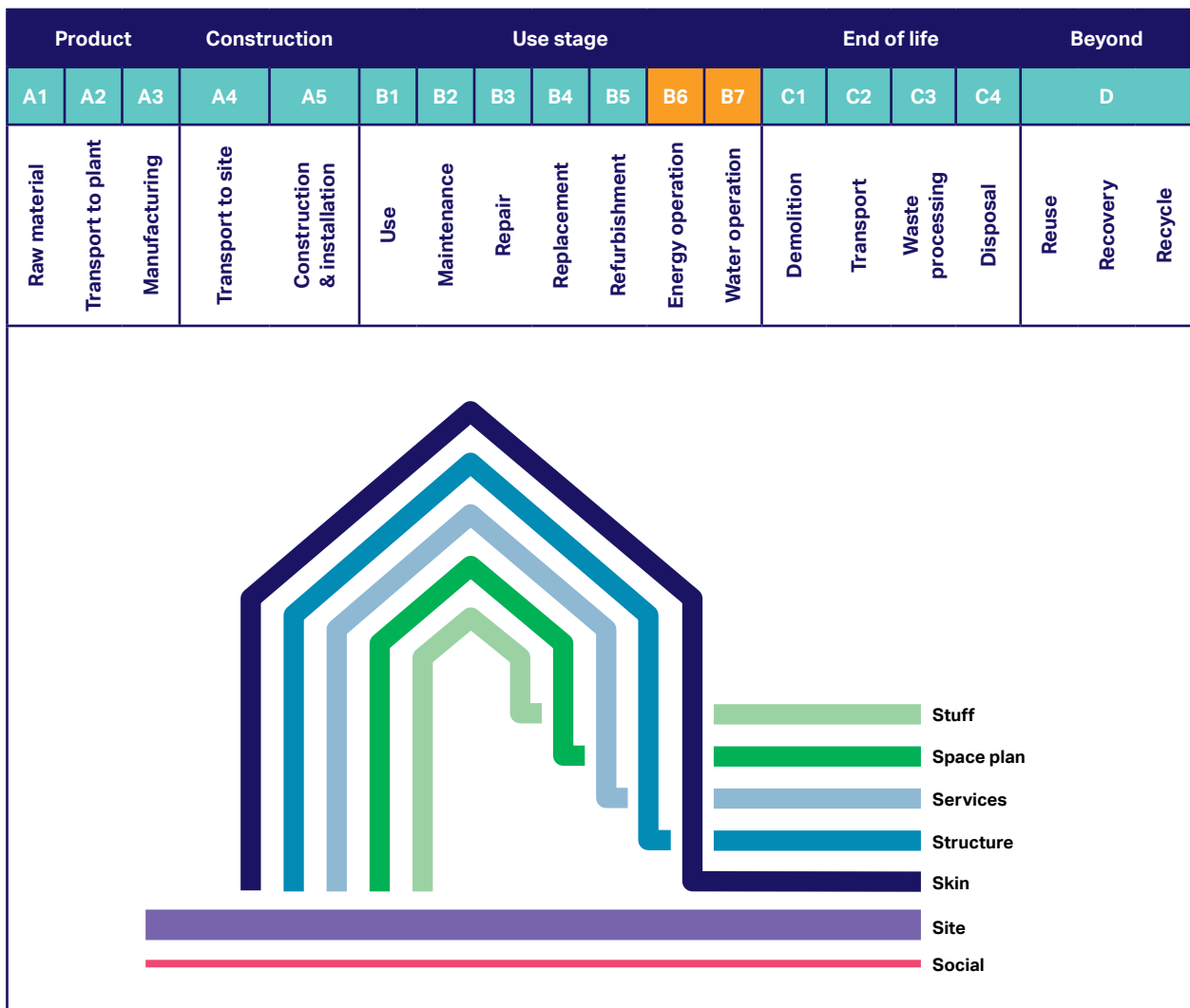
which presents the results of six case studies developed from Arup projects using whole life-cycle assessments based on the BSCF. The case study report indicated the potential for clearer, more ambitious carbon targets to emerge and the imperative to halve global buildings-related emissions within the next decade.

This **Net-zero buildings: Halving construction emissions today** report builds on our previous work and aims to provide a deep look into potential strategies and measures that companies might deploy to halve embodied carbon emissions – those associated with building components – by 2030.

## Previous findings – Where do we stand?

As demonstrated in the previous **Where do we stand?** report, as buildings become more energy efficient in general, in some cases embodied carbon already accounts for more than 50% of a new project's whole life carbon footprint. Importantly, a major component of this embodied carbon is the **upfront carbon** associated with the initial construction process and hence reaching the atmosphere at the very outset. Although some of these carbon emissions are classified as hard to abate, we can, and we must, aim higher and immediately develop buildings

**Figure 8:** Building Systems Carbon Framework (BSCF) – Whole life cycle stages and building layers



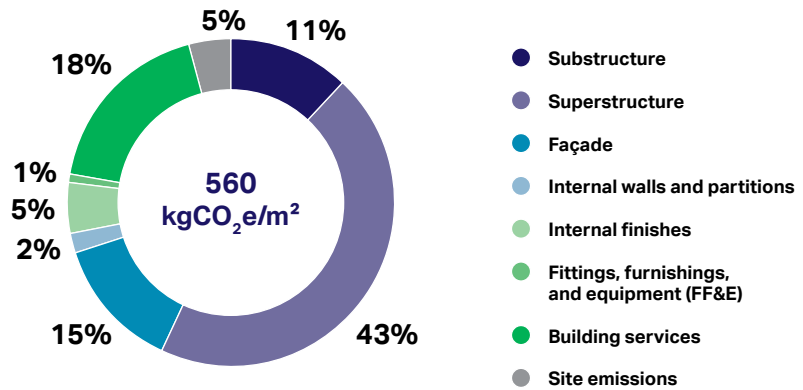
with significantly less embodied carbon if the sector is to achieve the overall net-zero targets we strive for.

We explored in detail the whole life carbon emissions of six building projects. These building projects are all in Northern Europe, generally had a sustainability focus, and hence considered at the advanced end of business-as-usual construction. However, the general conclusion of the report pointed to the urgent need to better collaborate across the whole value chain to drive systemic change and large-scale genuine decarbonization if the built environment industry is to play its part in limiting global warming to a 1.5°C increase in line with the Paris Climate Agreement.

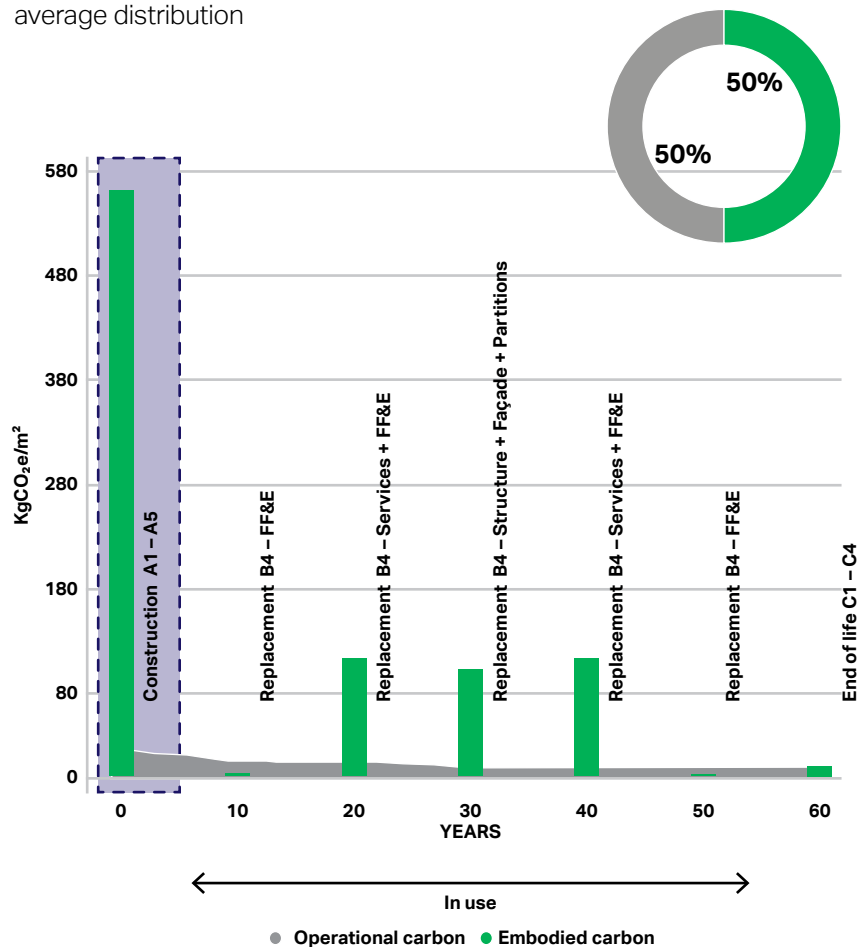
Embodied carbon represented an average of 50% of the total whole life carbon emissions of new building projects when considered across the 60-year life span of the six case study buildings we studied. Generally, national, and local legislation and predicted national grid decarbonization levels are driving improvements in operational energy. These developments push the balance of whole life-cycle emissions toward an ever-higher percentage of embodied carbon. Further, the largest part of this embodied carbon is in the immediately emitted upfront construction stage (A1-A5).

Although it is essential to consider carbon impacts holistically (embodied and operational) in relation to the best whole life carbon outcomes for buildings, companies must be concerned about the immediate impact of the construction stage over the next decade. In this report we focus on the global need to at least halve the business-as-usual impacts of A1-A5 construction stage emissions by 2030.

**Figure 9:** Upfront embodied carbon (A1-A5) average distribution across all six case studies



**Figure 10:** Whole life carbon emissions through time – average distribution



## Business-as-usual

There is currently no unified consensus on what average business-as-usual construction stage embodied carbon numbers might be. As such, there is no firm and consistent view as to what a target number representing half might be. However, based on industry benchmarks, research, and a growing number of calculated building life-cycle assessments (LCAs) for embodied carbon, in this report we assume as a starting point a global average upfront (A1-A5) value for a typical new commercial building of around 800 kg CO<sub>2</sub>e/m<sup>2</sup>.

Some studies focus on parts of the industry and regions where thinking about lower carbon designs is already developed<sup>7,9</sup> and show average numbers below this figure. Numbers are also emerging without consistently covering the full building layer scopes outlined in this report. This highlights the necessity to define consistently derived, clear benchmarks and hence reductions targets at a regional level to drive informed systemic reductions.

Figure 11 is an extract from a recent One Click LCA report<sup>9</sup> that assesses embodied carbon data for 3,737 European building projects summarizing average upfront structural and skin layer (baseline) embodied carbon results. For office buildings, there is an average value for structure and skin layers of about 450 kgCO<sub>2</sub>e/m<sup>2</sup>, which would correlate with the overall assumption for all layers of about 800 kgCO<sub>2</sub>e/m<sup>2</sup> referenced when also taking stages A4-A5 (transport and construction) emissions into consideration.

Figure 11: Impact of optional scopes on A1-A3 embodied carbon (EU)

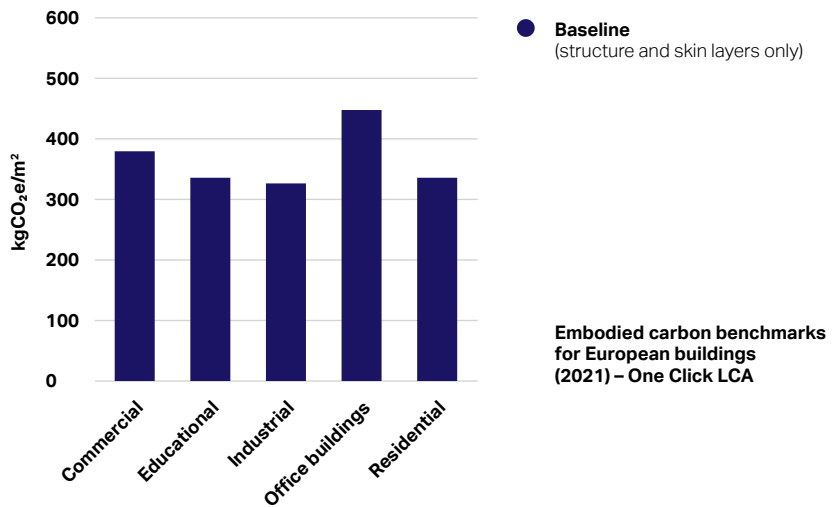


Figure 12: Estimated typical upfront embodied carbon (A1-A5) distribution

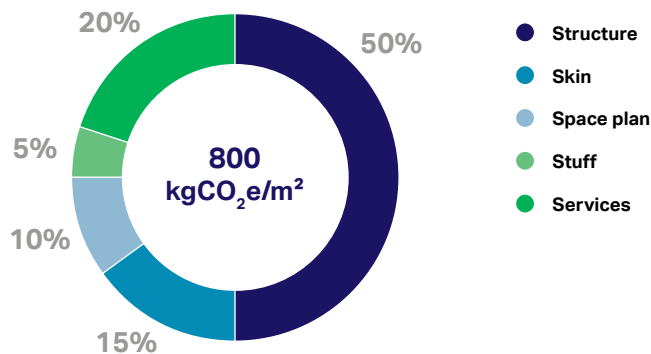
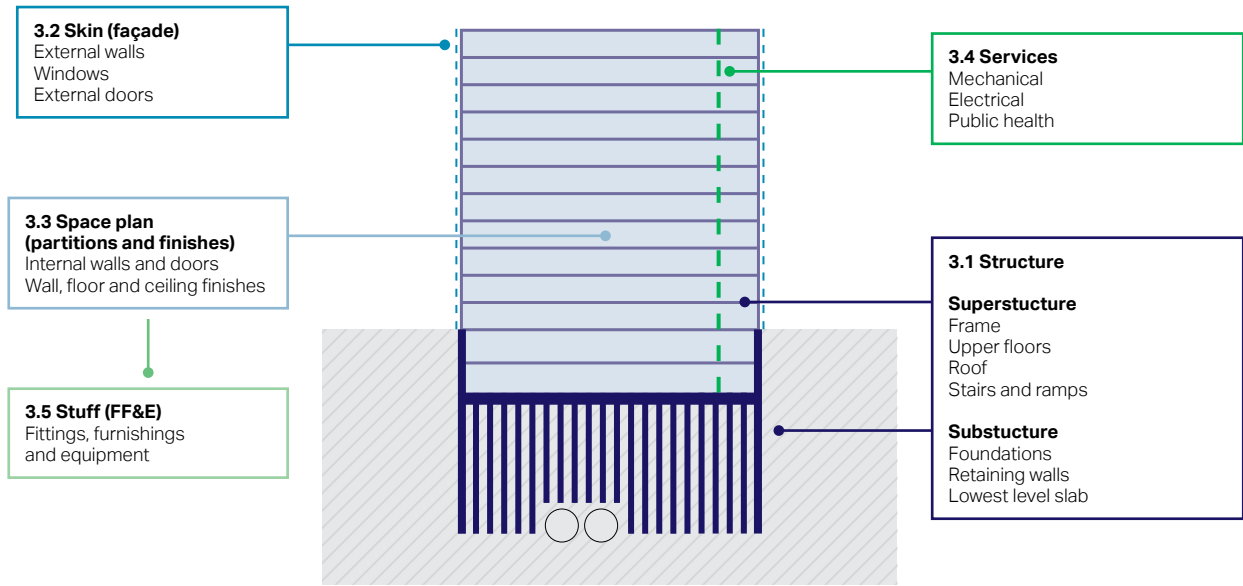


Figure 12 shows an estimated distribution of carbon within the building layers for the same typical commercial building extrapolated from our previous report results. Halving whole building carbon emissions by 2030 would represent an upfront embodied carbon target around 400 kg CO<sub>2</sub>e/m<sup>2</sup>, which currently correlates with numbers pointed

out by organizations such as the London Energy Transformation Initiative (LETI)<sup>10</sup> in the UK and the Carbon Leadership Forum (CLF)<sup>11</sup> in the US. Again, companies are beginning to conceive projects now that they will deliver in 2030.

**Figure 13:** Building layers



**About this report**

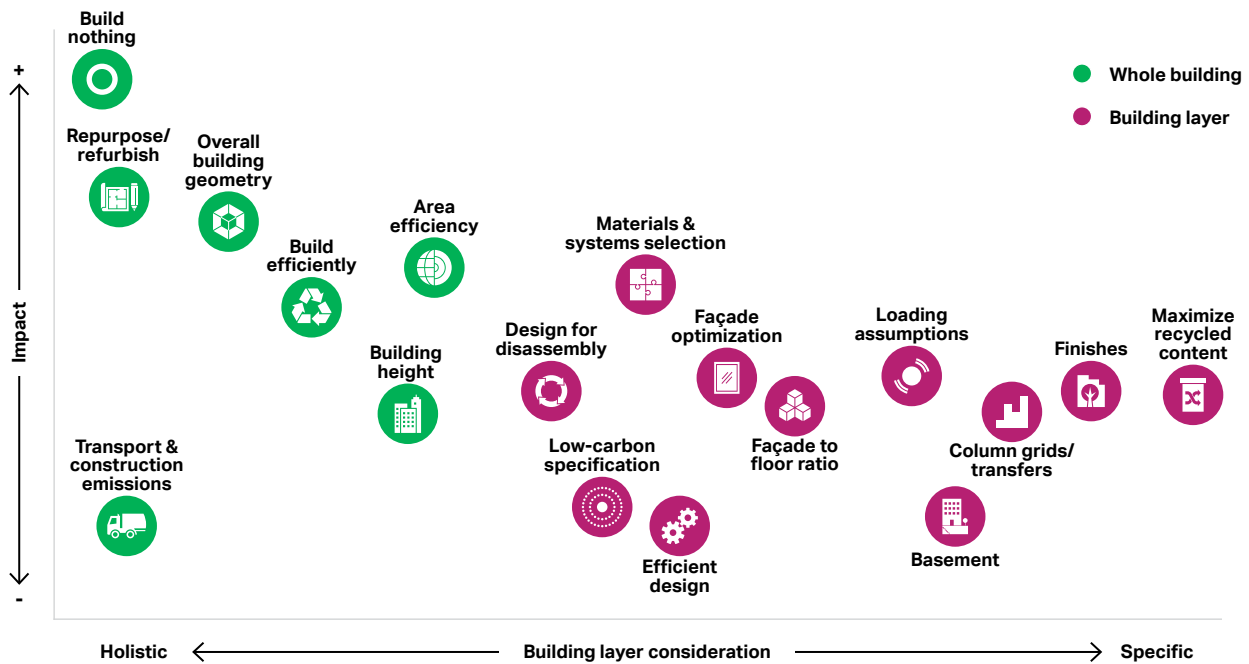
In the report we break the building up into its different layers, as presented in the BSCF, and explore the drivers, opportunities, and barriers to significant carbon reductions in the individual building layers.

A chapter looking at the more general decisions that are made in terms of planning the building from a holistic perspective will precede the chapters on the individual building layers. Often these key decisions, many made early in the overall delivery process, will straddle multiple building layers, and shape their outcomes significantly.



## ② Key high impact carbon reduction strategies

Figure 14: Key overarching considerations



By focusing on major carbon reduction strategies from the earliest point in every project, it is possible to create an environment where the systemic reductions required become possible.

### Consider carbon from the outset

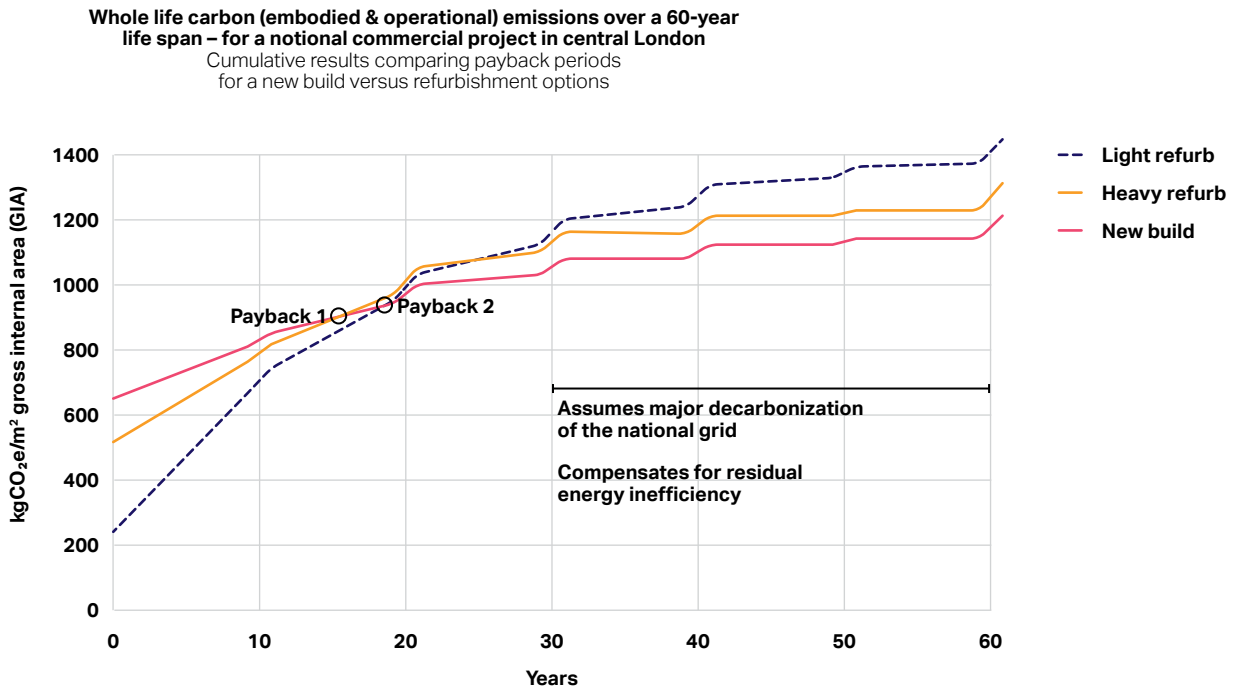
The biggest reduction opportunities take place at the earliest stages of a building's conception. At the outset of all building projects, AEC firms should clearly consider the necessity to build at all. When companies look at this decision and assess what they might be able to reuse and repurpose in terms of existing buildings, they must consider the whole life-cycle impact of all the decisions they

make. They cannot simply assume it is always beneficial to save, for instance, an existing structure and/or façade if it compromises the building's efficiency and performance beyond the savings in carbon it offers. Carbon payback periods must become a common metric they review fundamental early-stage decisions through as they already do under the lens of monetary cost. Figure 14 demonstrates one such analysis through a particular outcome, although we note that another example may demonstrate a different outcome. The key point is companies must study this with appropriate rigor at the outset of all projects to frame the best carbon outcomes.

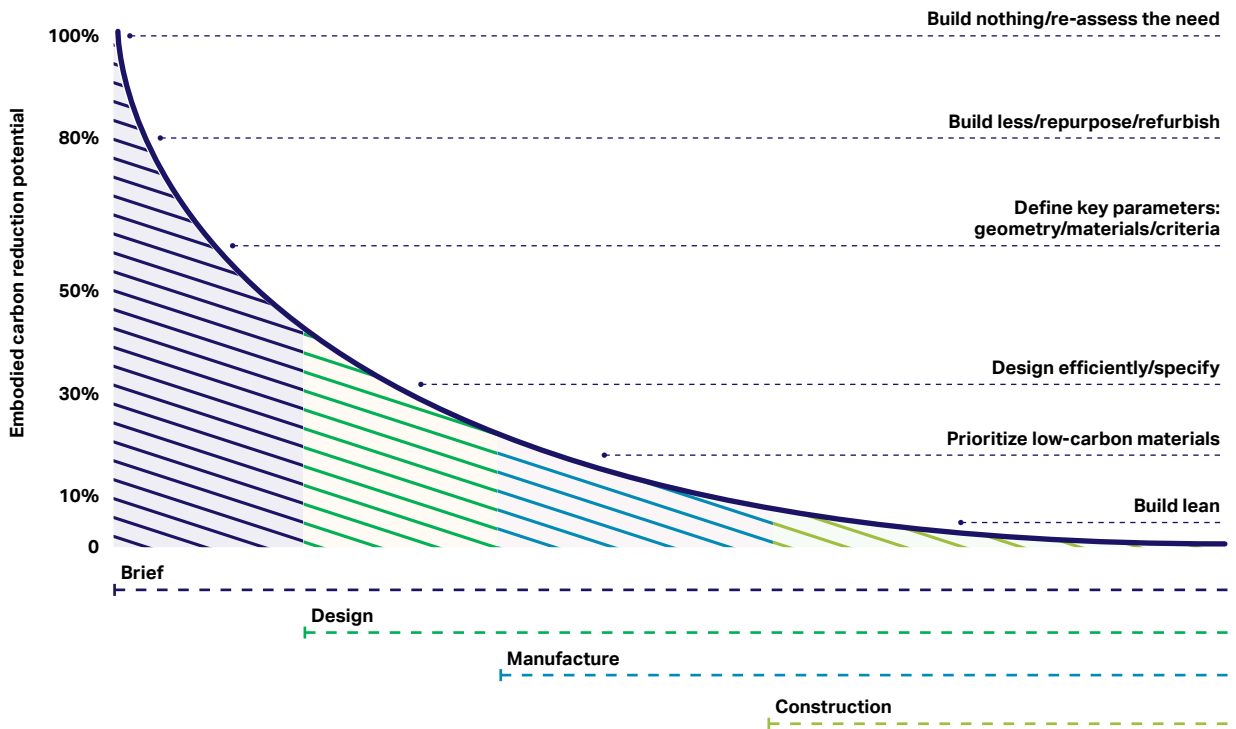
From our previous **Where do we stand?** case study work, we estimated the overall whole life carbon associated with the structure was an average of approximately 20% of the total 60-year whole life carbon emissions. If we add in the initial upfront embodied façade component, we average around 25% of the whole life carbon emissions. At around a quarter of the total whole life carbon expenditure, this is clearly an important and significant deliberation at the start of any building project where there is the opportunity to retain or repurpose an existing building.



**Figure 15:** Understanding carbon payback periods



**Figure 16:** Impact of decision-making in time



### Prioritizing carbon alongside cost

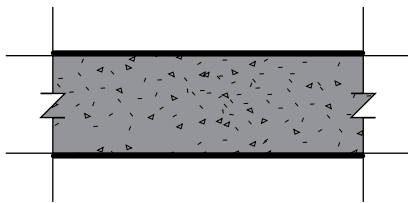
Often, real reductions in construction-embodied carbon mean a reduction in resource use. By extension, they should ultimately result in a reduction in cost. This is not always the case as firms typically do not price carbon into the equation. For instance, in certain geographies the balance in labor costs and energy costs will drive the use of systems or solutions

that are not the most optimum from a carbon perspective. As an example, in countries with high labor costs, companies will often prefer materially heavy construction solutions such as reinforced concrete flat slabs despite their carbon inefficiency as they can be built quicker, with less labor and less complexity in terms of fitting out around them.

When valuing carbon appropriately, cost should also not drive the choice of materials

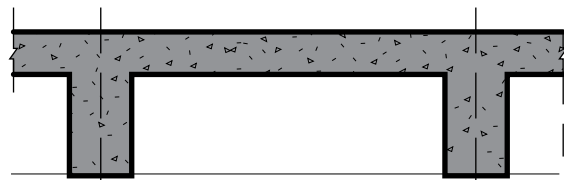
and products toward poorer general quality, flexibility and longevity as companies will have to replace elements with a short lifespan more often throughout the building's life. To drive thinking toward the highest level of decarbonization, companies must appropriately value carbon in the decision-making process alongside cost.

Figure 17: Reinforced concrete flat slabs



Typically 180 kg CO<sub>2</sub>e/m<sup>2</sup> for a 9x9 m grid with comparable loading

Figure 18: Reinforced concrete waffle slabs



Typically 120 kg CO<sub>2</sub>e/m<sup>2</sup> for a 9x9 m grid with comparable loading



Arup – 88 Wood Street – Daiwa Europe House

## Carbon as a new appropriately priced cost parameter

### Building geometry

The overall initial planning of a building's geometry can have a big impact on its carbon footprint. Companies need to assess the carbon impacts of the choices made on the geometric massing of buildings in terms of the floor layouts, core layouts, column grids, floor-to-floor heights and wall-to-floor ratios, among other considerations. Good, informed decision-making on these key building geometry parameters

can put the industry on the way to the significant embodied carbon reductions needed.

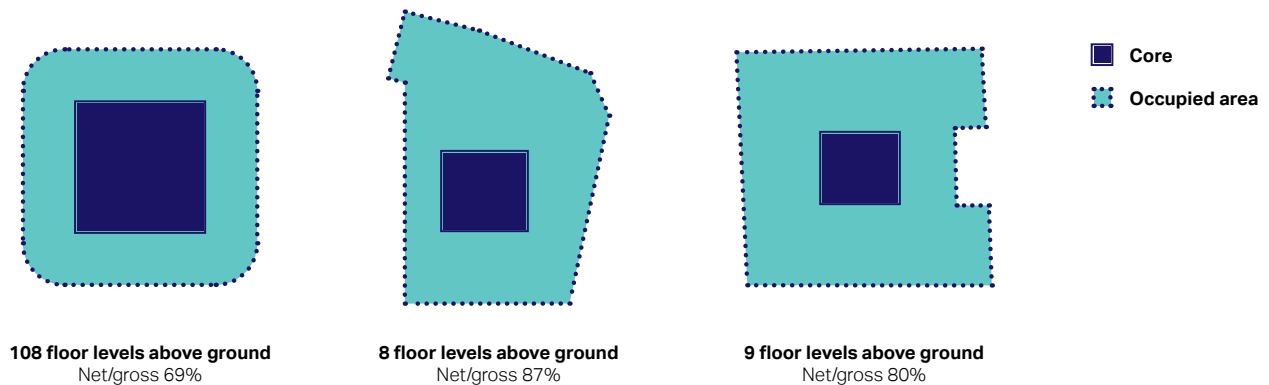
### Area efficiency

One aspect to consider at the outset is the overall efficiency factor of net usable area to gross construction area achievable. Often what is commonly referred to as the net-to-gross ratio can vary by more than 20% in different versions of the same building typology. This indicates that at the lower efficiency numbers companies are constructing more overall building to deliver

the same functionality. Often companies naturally optimize the net-to-gross ratio from a cost-efficiency perspective, but they should also consider it from a carbon efficiency perspective at the outset.

Building height also impacts area efficiency for the reasons outlined below.

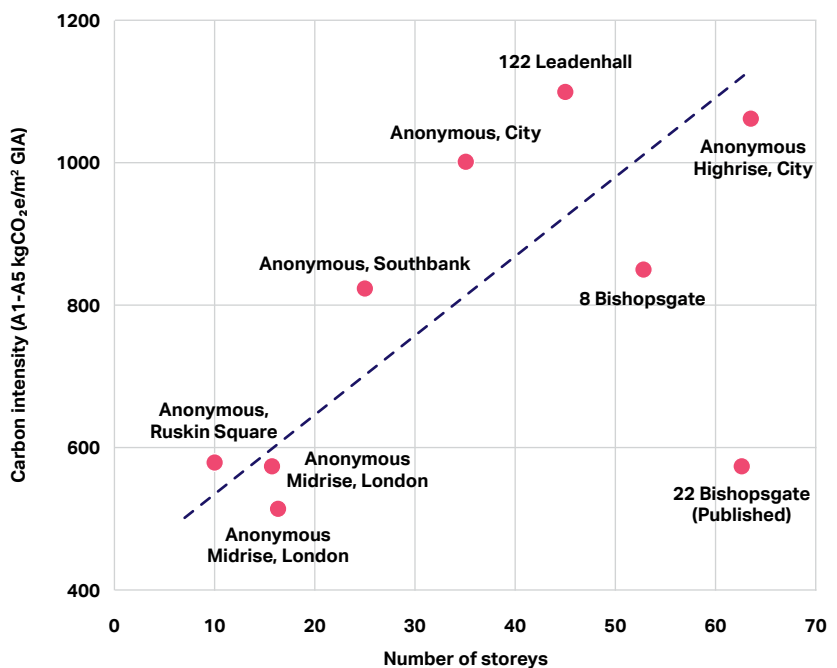
Figure 19: High-rise vs low-rise – floor efficiency



### Building height

As buildings become significantly taller, they typically require more structure (thicker core walls, bigger columns, larger foundations, etc.) and more space and equipment associated with vertical movement of people (lifts and stairs) and building services (risers, interstitial plant provision, etc.). As well as requiring more material and systems, the net-to-gross ratio of tall buildings naturally starts to fall due to the addition of extra vertical circulation provisions and as such there is a double hit when carbon intensity is measured against the effective usable (net) area of the building. Often this can mean an embodied carbon expenditure of more than 50% additional is required to provide the same net useable area between high-rise and low-rise construction.

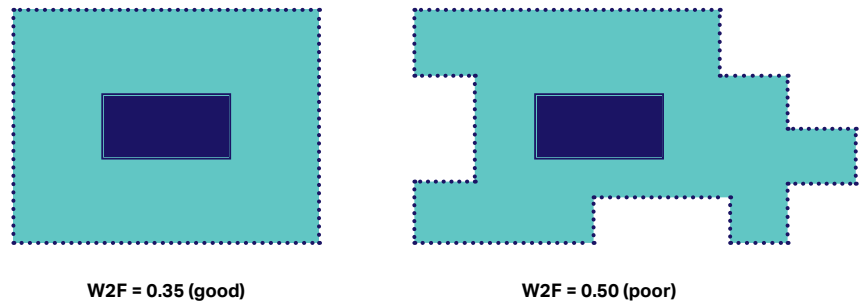
Figure 20: High-rise benchmarking



### Wall to floor ratio

A major influence in terms of the skin – or façade – of a building is related to the efficiency of the wall-to-floor ratio achieved via the general massing arrangement. This ratio can vary significantly for a wide number of reasons, often avoidably. Typically, the ratio can vary from about 0.3 to 0.5 and hence at its upper end represent more than 60% of additional façade area compared to the optimum lower end of the range, driving additional carbon into the design.

Figure 21: Wall-to-floor (W2F) ratio



Wall to floor ration comparison showing in excess of 40% range

### Column grids and floor-to-floor heights

The column grid and allowable floor-to-floor height can have a major impact on the embodied carbon outcome. The span of the building floor plate between columns and walls and the allowable depth the structure can occupy (span-to-depth ratio) can significantly impact the overall amount of material needed to effectively perform the same overall functional requirement, which in turn is directly linked to the overall carbon footprint.

By considering the impacts of all the geometric parameters outlined above holistically, there is obvious potential to optimize the embodied carbon at the earliest point possible in the decision-making process. To do this, companies need to better estimate and consider embodied carbon in relation to all the possible variables, to an appropriate degree of accuracy, at the earliest point possible in the design process.

Figure 22: Span vs carbon relationship for a typical floorplate system

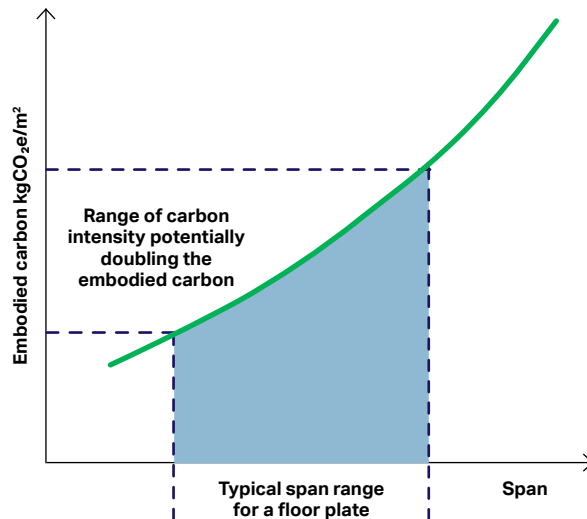
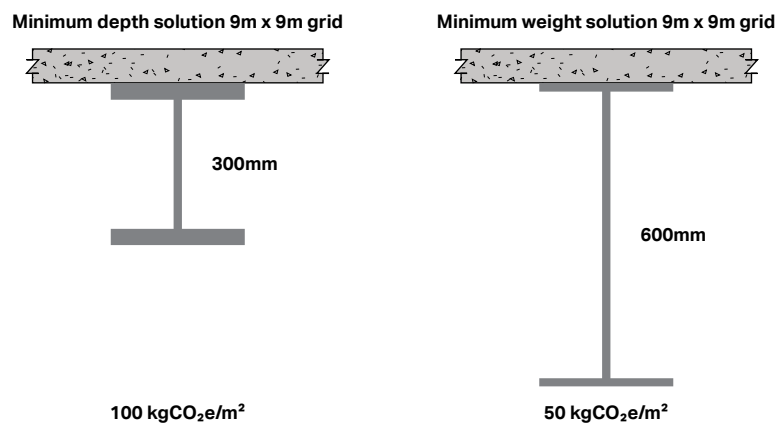


Figure 23: Weight-to-depth relationships for a comparable composite floor plate design



### Transport and construction emissions

The previous case study report shows that the majority (93%) of upfront construction carbon emissions are associated with the manufacturing of the products, components and systems used to build the building. For these typical building projects, the construction emissions associated with transport to the site and construction and installation processes were by comparison relatively small (less than 7%). Companies should

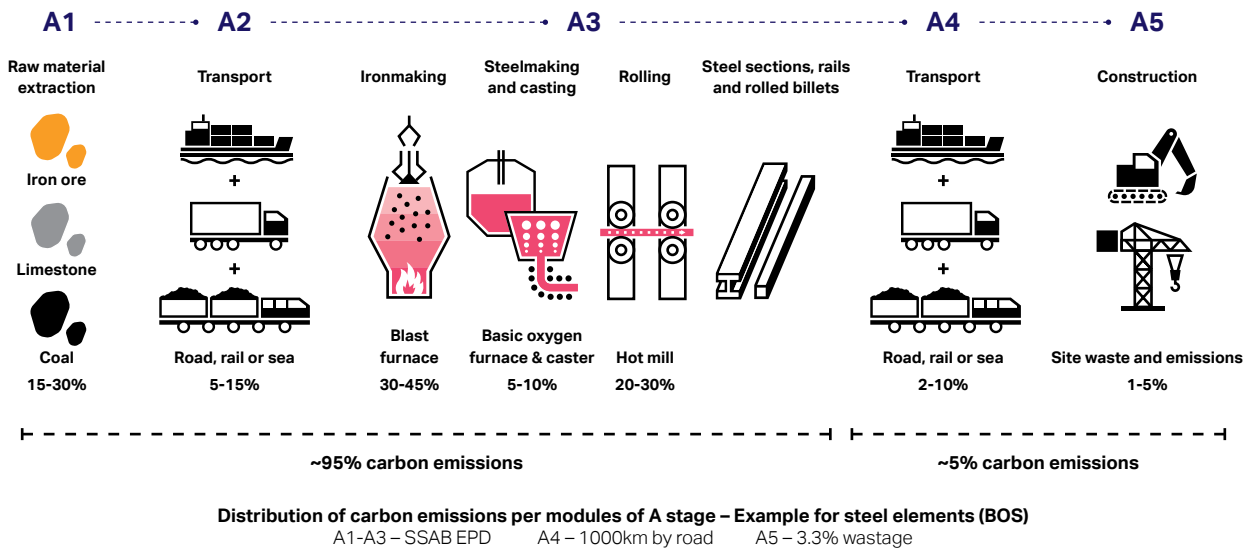
clearly aim to decarbonize as much of the construction (A4 and A5) activity as possible via the adoption of electric vehicles (EVs), cleaner processes, less waste, more offsite fabrication, etc.

We recognize that the ratio A1-3 (manufacture) versus A4-5 (placement) will also vary depending on the materials adopted in the construction process. For instance, the use of timber in the manufacturing process will be comparatively less carbon intensive and companies

should place greater emphasis on transport and construction compared to steel and concrete construction.

Therefore, to make the most meaningful impact, companies need to clearly recognize and prioritize the biggest components of upfront embodied carbon and always focus attention on the largest opportunities for possible reduction.

Figure 24: Stage A1-A5 – steel product life cycle



Arup – 80 Charlotte Street

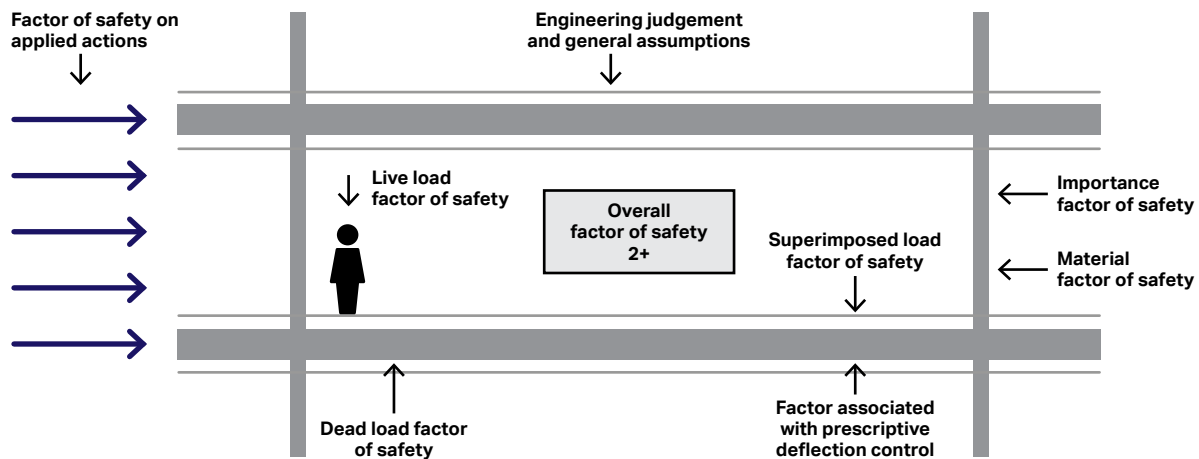
### Standards and codes of practice

Standards, codes of practice and regulations that shape the development of building design and specification typically do not consider carbon as an outcome. Codes of practice and regulations, driven by the necessity to unify and homogenize approaches, are often by nature conservative and drive a certain level of redundancy and over-design beyond what companies might consider if they made each decision based on project-specific

first principles, as opposed to a prescriptive requirement. As codes of practice and regulations develop alongside the industry's ambitions to radically decarbonize, governments should give more consideration to carbon efficiency as an outcome. Developing codes to require future designers to take more responsibility for balancing performance, safety, and carbon via better performance-based understanding would lead to more carbon-efficient designs.

In the same project-specific performance design approach, designers might also consider future flexibility by designing it explicitly into key elements, for example columns, walls, foundations at an appropriately minimal level of carbon impact that much leaner design can balance elsewhere, all of this supported via digital records in perpetuity.

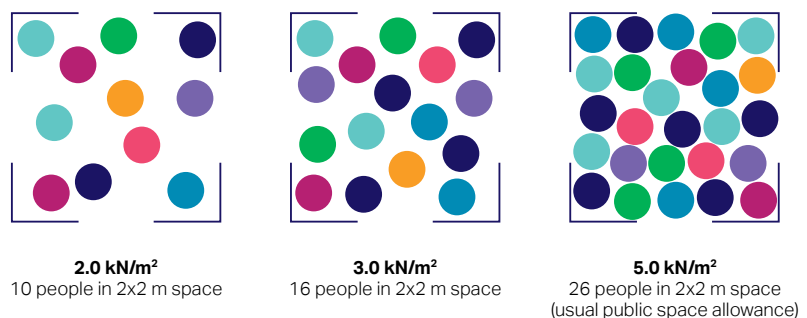
**Figure 25:** Typical prescriptive safety consideration factor



### Design criteria

Generally, the development of the most common criteria that drive building designs does not consider minimizing embodied carbon. A particular example of this is perhaps the imposed (people) loads companies design structures to. Typically, the assumed loading criteria has taken a conservative approach, focusing on capturing all possibilities whether they are likely or even credible. Often the real scenario is a floor plate in a building will only ever see a small fraction of the maximum imposed design loads of its design specification, meaning much of the material used has been wasted.

**Figure 26:** People density



Criteria such as the real-time occupancy levels of buildings also dictate the design of building services and lifts, which companies typically design to codes that assume worst case scenarios. Perhaps moving

forward, companies can be more thoughtful about the real maximum life-time criteria the designs will see and design for real performance, maybe even using modern digital sensor technology to enable this.

**Design for manufacture**

The development of building componentry and systems has the potential to lead to lower carbon solutions. Rather than designing each building as a bespoke proposition, if the company constructs it from a system of pre-developed and manufactured components it can continually refine, innovate and optimize the system in relation to its carbon footprint.

Tracking and reporting the carbon associated with modular systems should also ultimately be more rigorous as companies can establish environmental product declaration (EPD) documentation for each of the repeating components.

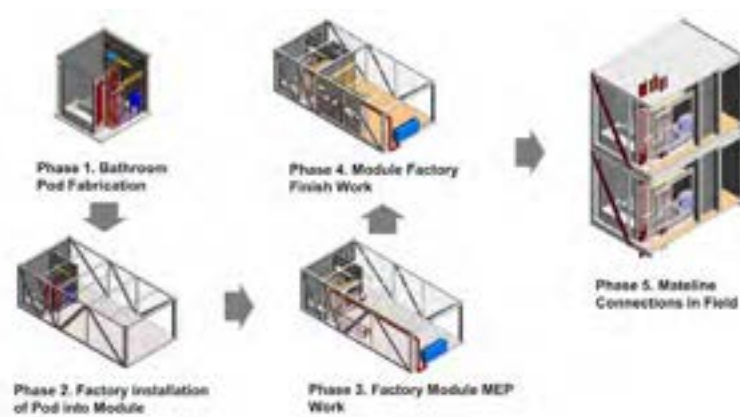
**Figure 27:** Laing O'Rourke Explore Plant robotically manufacturing precision reinforced concrete building units.



**Figure 28:** Custom made engineered timber components – StoraEnso Sylva kit.



**Figure 29:** Factory built volumetric modular housing – Atlantic Yards B2 Tower



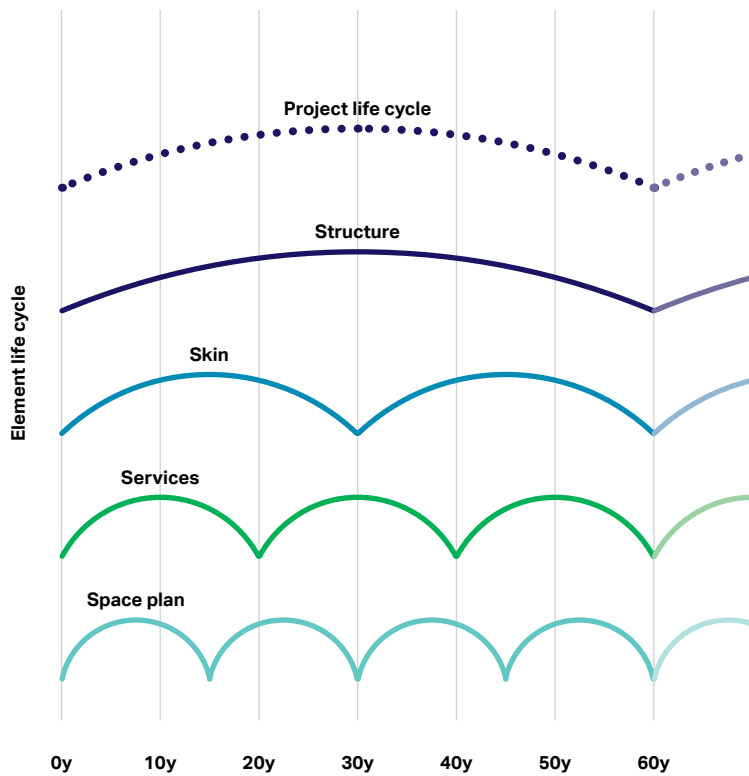
**Whole life carbon & circularity**

For the reasons presented above, this report focuses on upfront embodied carbon (A1-A5). However, it is also important to look at all embodied carbon stages, as well as operational carbon, ensuring the equal consideration of each and that companies do not compromise their reduction by decisions made at the outset.

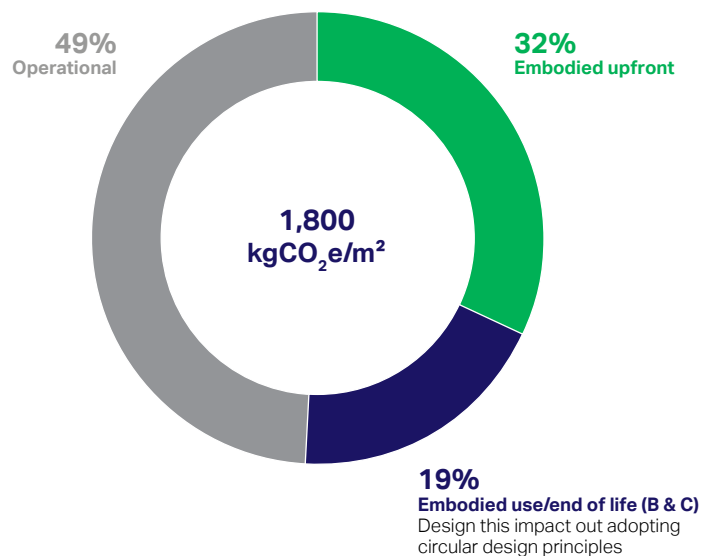
It will become increasingly important to understand the decarbonization trajectories of the built environment supply chain in terms of the replacement of materials and products used at cyclic intervals throughout a building's life. Figure 30 shows a typical set of life cycles across the various building layers.

As well as looking for lower carbon solutions within these building layers, companies must consider more circular approaches to their provision. They need to be designing with minimal carbon impacts for life-cycle replacement, maximizing the potential to reuse building layer componentry at their highest possible reuse potential.

**Figure 30:** Building layer life cycles



**Figure 31:** Average whole life carbon breakdown of the six "Where do we stand?" case studies

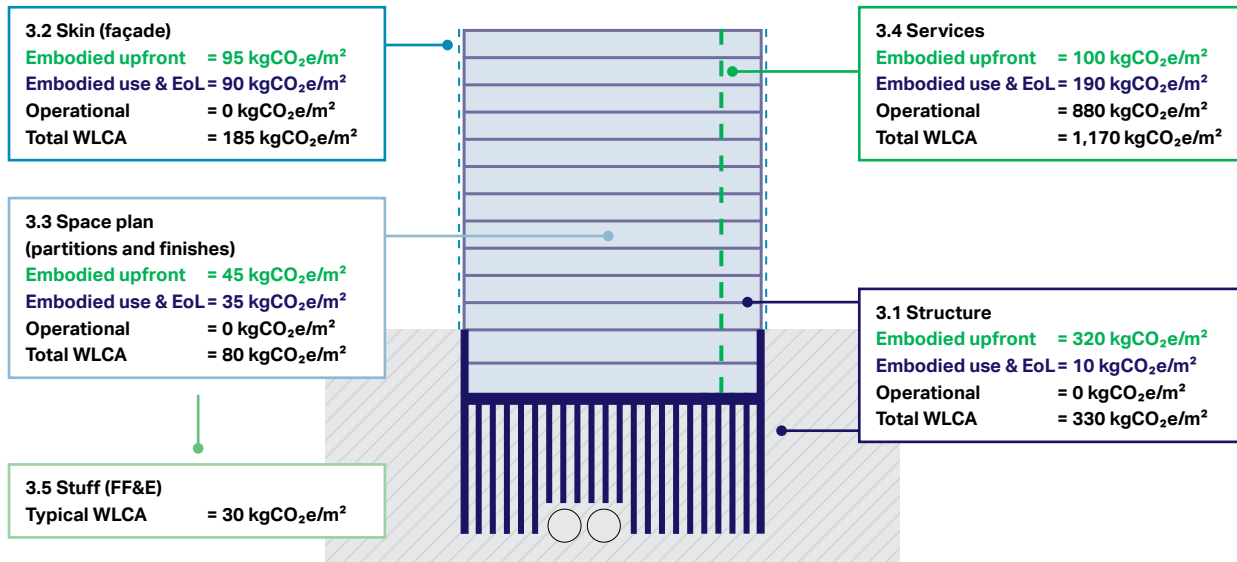


**To make the required systemic carbon impact reductions across our built environment we must collaboratively focus on shaping all future projects around the lowest possible carbon outcome from the earliest point in their inception.**



# ③ Building layers

Figure 32: Average carbon footprint across all six case studies per WBCSD framework distribution



## Our Where do we stand? study gave the following insight into where the average whole life carbon impact of the study buildings sat.

Although based on the small case study sample it starts to give an indication of where the most impactful focus areas might be. We can also compare our findings with the growing body of published work being brought forward as referenced in chapter 1.

We can see via the previous section that a limited number of key decisions at the outset of a project can have a major impact on the embodied carbon associated with the upfront construction stage (A1-A5). As we explore the subsequent building layers in more detail,

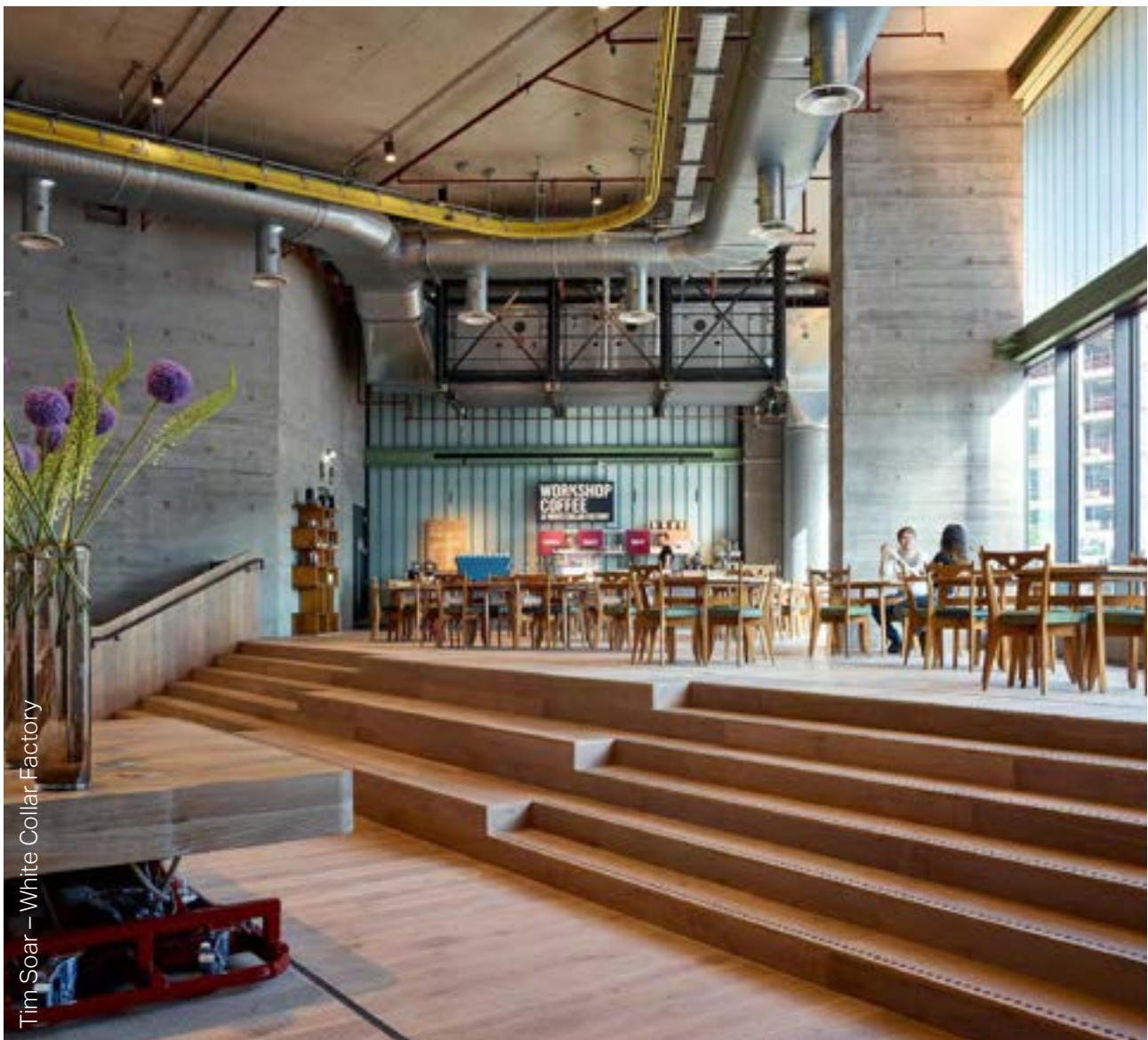
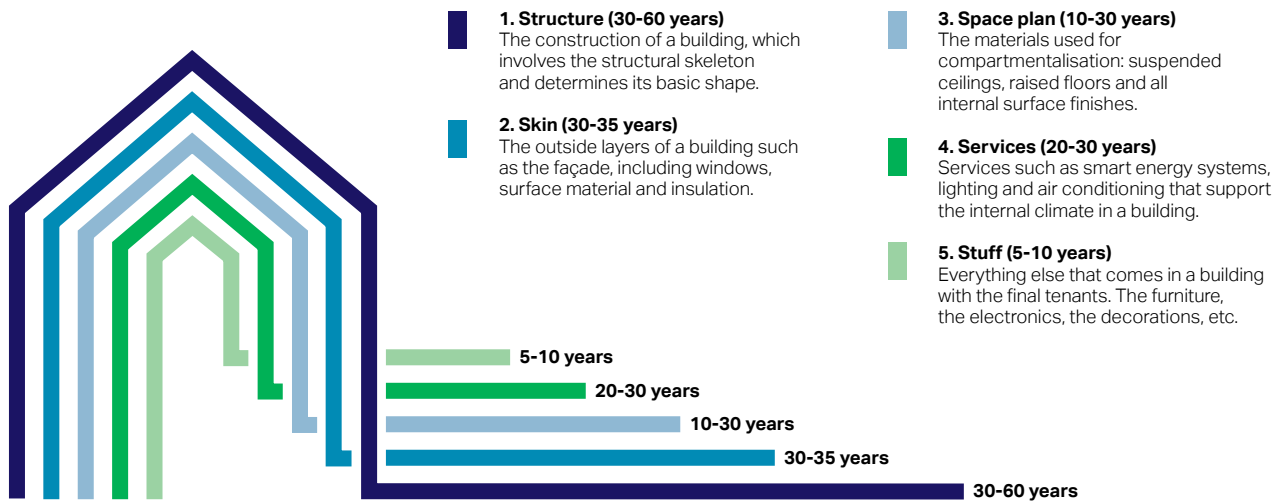
we will explore further upfront embodied carbon reductions and explore how we might make better decisions in relation to embodied carbon expended during building use via exploring more circular design principles.

Business as usual estimates of total embodied carbon associated with upfront construction vary. Commonly quoted values sit in the range of 600-1,000 kgCO<sub>2</sub>e/m<sup>2</sup>. This suggests that an upfront construction stage total embodied carbon target associated with a halving of business as usual might sit around 400 kgCO<sub>2</sub>e/m<sup>2</sup> as pointed to in the introduction. If we are asking **"How do we halve construction emissions?"**, can the maximum bar for this question be at 400 kgCO<sub>2</sub>e/m<sup>2</sup> or even lower?

**How do we achieve a maximum upfront construction stage (A1-A5) embodied carbon of < 400 kgCO<sub>2</sub>e/m<sup>2</sup>?**

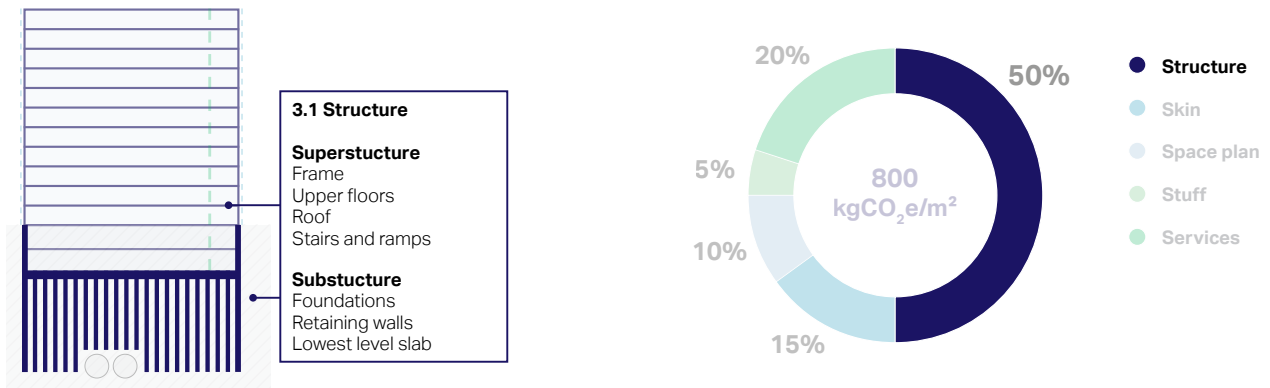
We look in more detail at the 5 building layers within the WBCSD Building Systems Carbon Framework (BSCF), pointing to opportunities for and barriers to significant decarbonization.

**Figure 33:** Building systems carbon framework - building layers



# 1 – Structure (sub-structure and super-structure)

Figure 34: Structure and upfront embodied carbon (A1-A5) estimated typical distribution



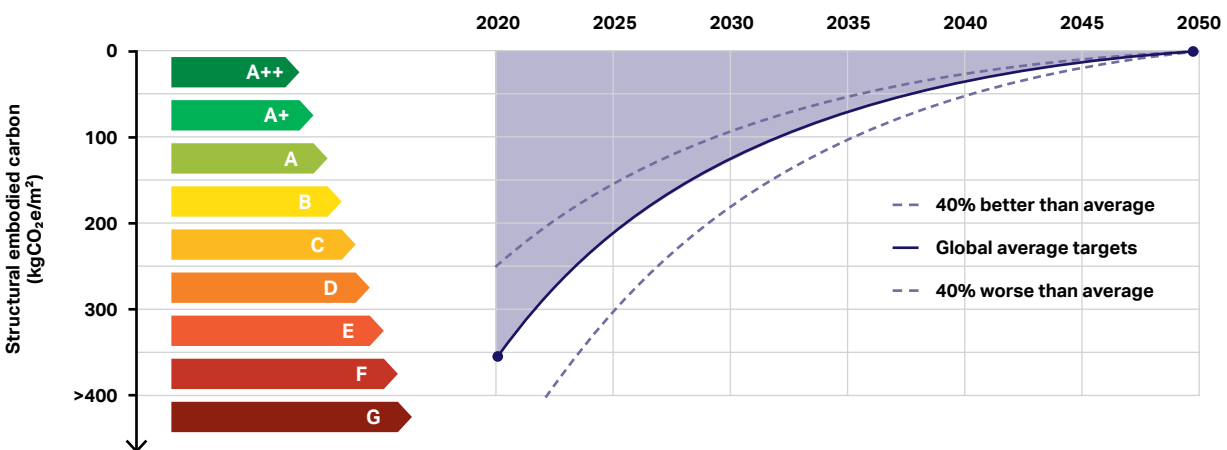
## How do we halve construction emissions?

Although the exact breakdown of embodied carbon across the building layers varies, the structural building layer (sub-structure and super-structure) can typically represent around 50% of the

upfront construction stage embodied carbon. Given the above premise for limiting all upfront construction stage embodied carbon, this would create an immediate target for the structural layer of about < 200 kgCO<sub>2</sub>e/m<sup>2</sup>. This target would correlate reasonably well with recent work undertaken by the

Institution of Structural Engineers (IStructE), which has attempted to project global structural design targets aligned with limiting associated construction emissions to net-zero by 2050. Figure 35 shows the IStructE Structural Carbon Rating Scheme (SCORS) targets.

Figure 35: Yearly design targets for structural embodied carbon

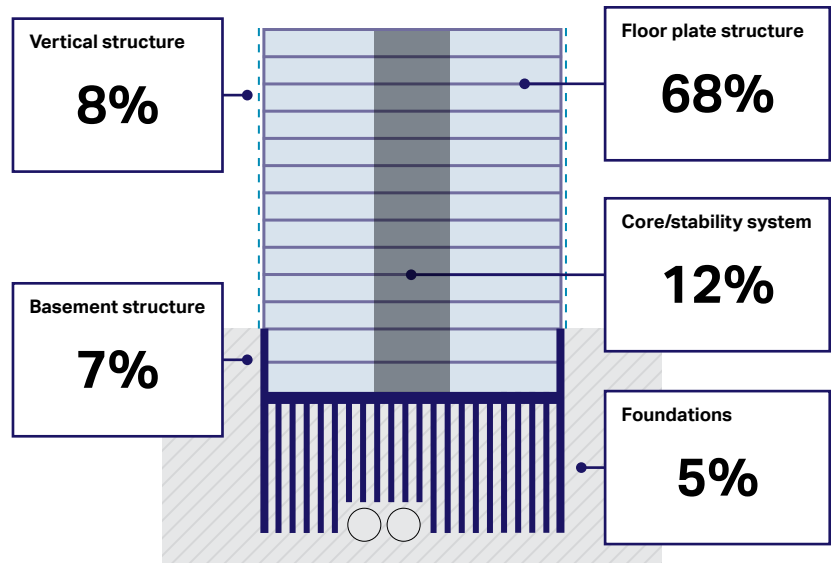


Source: IStructE Proposed Structural Carbon Rating Scheme (SCORS)<sup>12</sup>

The structural layer results across the 6 case studies we explore in the **Where do we stand?** report range from 150 – 480 kgCO<sub>2</sub>e/m<sup>2</sup>, although it should be noted that the lower end of the values represents projects that had major structural reuse components.

Often, early in a project, companies can identify areas of the structural layer that contain a proportionally large component of the overall structural upfront embodied carbon, such as the floor plate. These areas should provide a particular focus for early reduction strategies.

**Figure 36:** Typical breakdown across the structure layer (note varies according to overall building massing)



### Plan for low carbon from the start

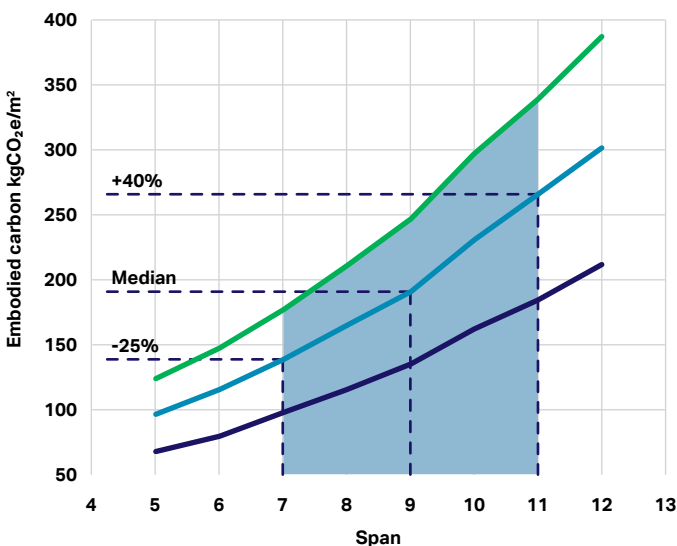
As already seen, key decisions, often made very early in the design process, can have a major influence on the embodied carbon impact of the structure. To radically lower the embodied carbon in structures, it is essential to change the way companies understand and prioritize carbon decisions associated with how they plan buildings from the outset.

The structural grids, meaning the spans chosen for structures, can have a marked impact on the material used and hence the embodied carbon expended.

Historically, companies have often prioritized excessive spans to create flexible column-free spaces because it is technically feasible. Perhaps companies have considered cost in this decision but have not typically considered the direct carbon impact.

Figure 37 shows for a typical concrete flat slab structure the impact of span against carbon. As can be seen, at a certain threshold a relatively modest increase in span can have a marked impact on the embodied carbon outcome. The figure also shows the potential impact of different assumptions in terms of the materials (reinforcement and cement) sourced. There is more on that later in this section.

**Figure 37:** Graph of span to carbon for a typical flat slab



- World values
- General values
- Low carbon values

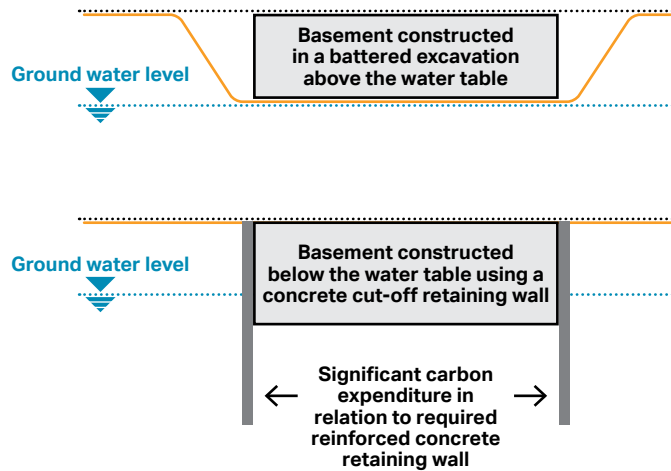
Carbon factor (kgCO <sub>2</sub> e/kg)	Concrete	Steel reinforced
World values	0.19	1.95
General values	0.15	1.5
Low carbon values	0.12	0.76

Often in framing structures at early design stages, companies will see the impact of changes in grid (column or wall locations) from one floor to next, which will require elaborate transfer structures. Sometimes these are necessary for unavoidable functional reasons. However, at times excessive use of carbon-intensive transfer structures is simply the product of poor spatial planning and coordination.

Another factor for consideration early on is the provision of basement area. Experience shows that basement construction is typically twice the carbon intensity of the same area constructed above ground. One key driver for the additional carbon associated with basements is the necessity to have a perimeter retaining wall, typically constructed from thick reinforced concrete. Given the carbon impact of the perimeter retaining wall, the shape of the basement plan as determined by the ratio of the wall length to the basement area contained is also a key factor.

How far the basement extends below the ground water level, its overall shape, and hence how complex the basement construction needs to be can have a notable impact on the carbon intensity of the structural layer.

**Figure 38:** Diagram showing open cut basement with simple retaining vs bored secant type wall



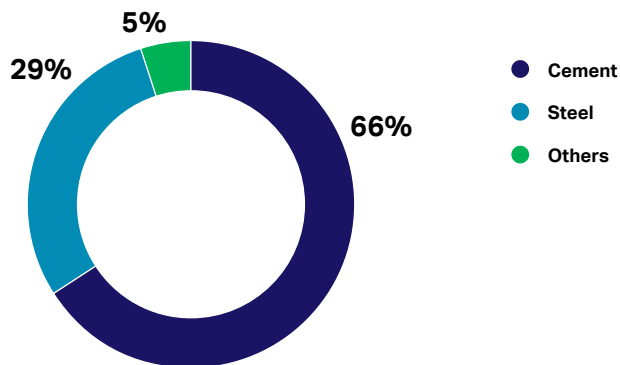
Arup – Citibank Plaza Hong Kong

## Material choices

In a global context, concrete and steel are the predominant structural construction materials by a large margin and will realistically continue to be so for the next decade and beyond. Companies should explore and develop timber and other lower carbon alternative materials but in doing this they should be conscious of the supply-demand dynamics and use any alternative materials so that they give the maximum genuine benefit in terms of reducing atmospheric carbon.

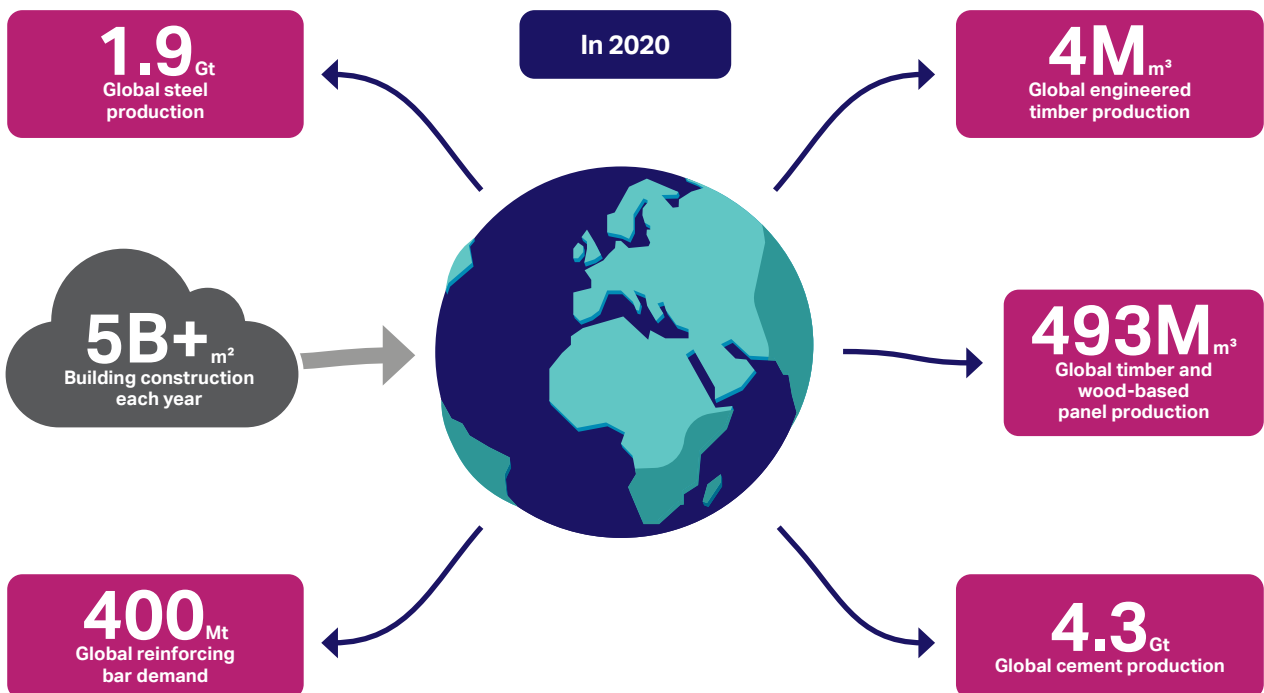
Companies should be conscious of the true impact of the decisions made at an individual project level, as the aim should be to drive down overall consumption (demand) to levels to where a global carbon-free supply can meet them.

**Figure 39:** Cement and steel contribution to global construction material carbon impact

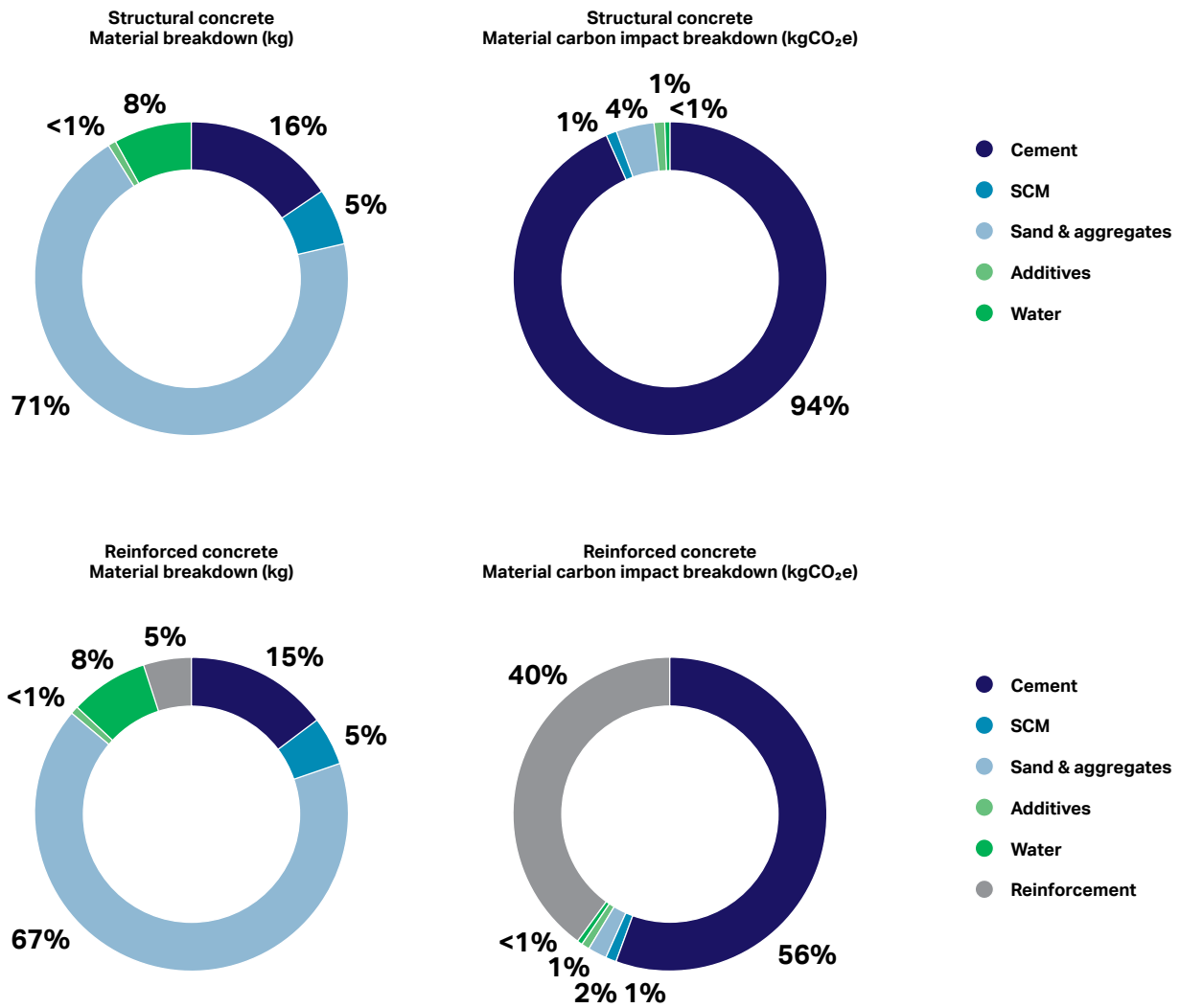


**Whatever material companies are using, they should aim to use as little of it as possible.**

**Figure 40:** Global construction demand versus supply<sup>13,14,15,16</sup>



**Figure 41:** Structural concrete and reinforced concrete



Ratios of material quantities versus material impact in a reinforced concrete mix C35/45

**Reinforced concrete**

There are several ways to reduce the carbon impact of reinforced concrete structures but the most immediately impactful way in real terms is to use less of the heaviest polluting elements, namely less cement and less reinforcing steel.

**Figure 42:** Reinforced concrete construction will remain prominent over the next decade



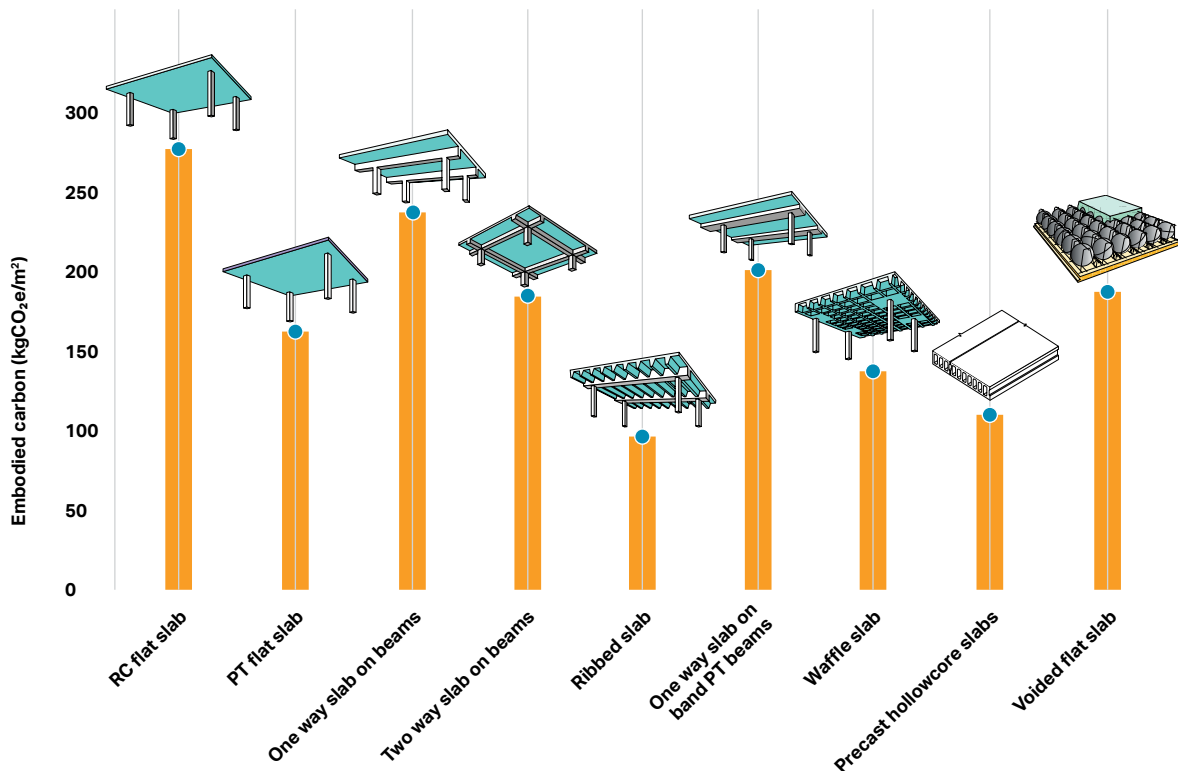
Often the carbon impact of various reinforced concrete solutions for the same overall performance objective can be very different and AEC firms should consider this carefully at the earliest opportunity.

Another method of reducing the carbon impact of reinforced concrete is to look to replace the heavier polluting components with much lower carbon intensity replacements. An increasingly common way of

reducing the impact of cement is to use low-carbon pozzolanic supplements (known as supplementary cementitious materials or SCMs) to replace a proportion of the high-carbon Portland cement clinker or used directly as a mineral component within the clinker manufacture itself. Commonly used SCMs are ground granulated blast-furnace slags (GGBS) and coal fly ashes (FA sometimes PFA), both byproducts of processes involving burning

fossil fuels. Structural concrete can be designed with more than 50% SCMs while retaining adequate design performance. However, note that available global supplies of GGBS and FA are limited to perhaps as little as 15% of current cement consumption. Any use on a local level above this global availability level is effectively limiting global supply to below this number.

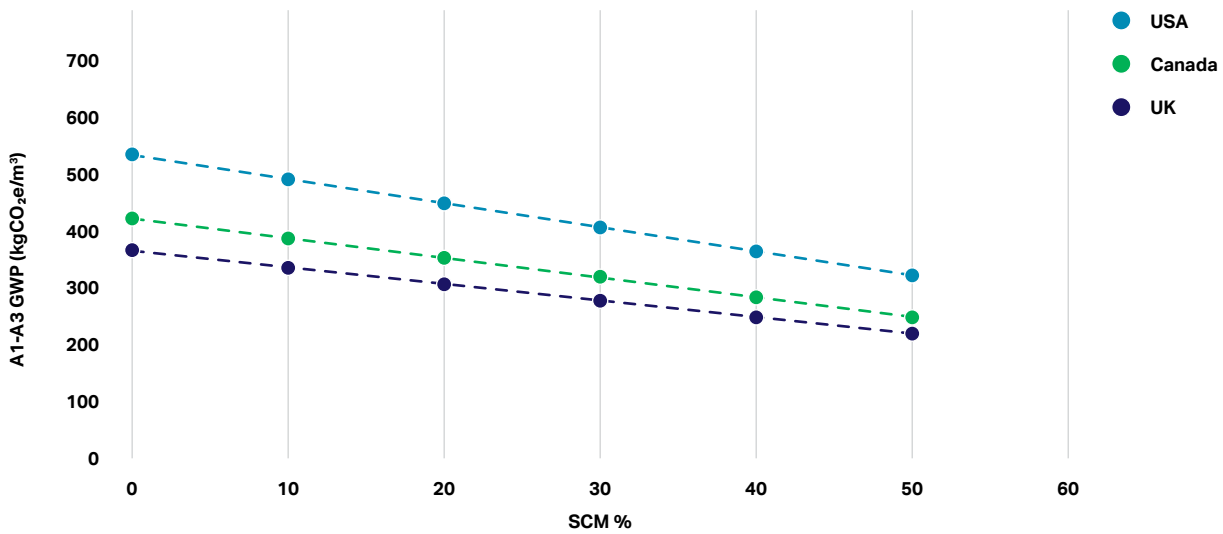
**Figure 43:** Comparison of common concrete floorplate systems<sup>17</sup>



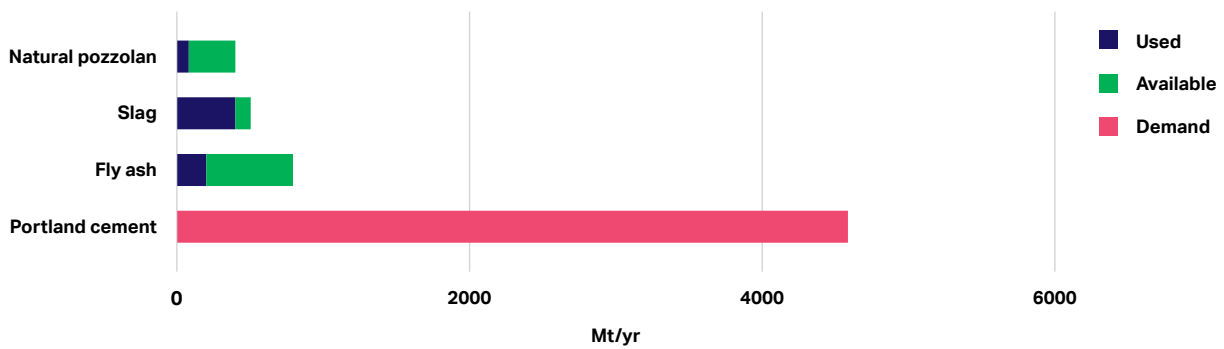
**Companies should not use GGBS and FA as a cement replacement in lieu of reducing concrete consumption to an absolute minimum but as an additional measure once they have exhausted possible further reductions.**



**Figure 44:** Supplementary Cementitious Materials (SCM) % by geography



**Figure 45:** Supplementary Cementitious Materials (SCM) and Portland Cement – Global potential annual supply & demand<sup>18</sup>



Companies should also recognize that as countries take coal fired power stations offline, many regions are already experiencing a scarcity of FA and the current levels of GGBS/FA will diminish as the burning of fossil fuels goes down globally. As such, their use in time is limited.

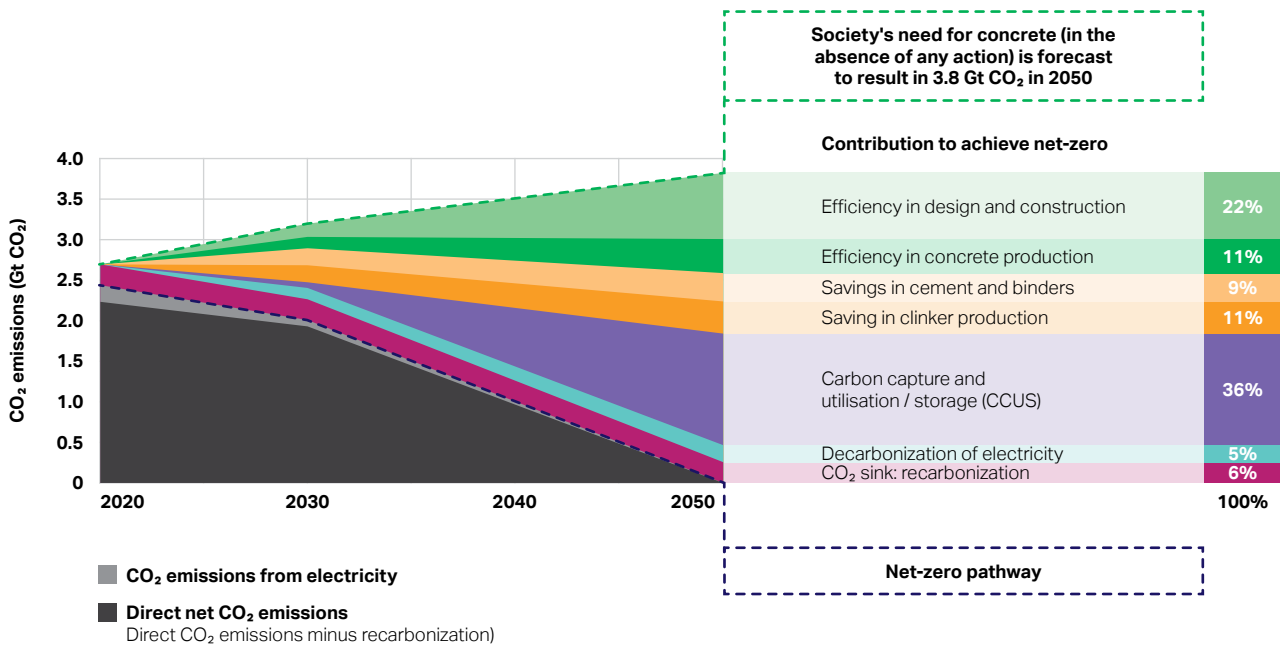
Companies are developing alternative, non-fossil fuel based SCMs and using them more widely. Natural pozzolans, the most widely used being calcined clay, are replacing GGBS/FA. Current availability is limited

to around 1.5% of cement consumption. Although available reserves are considered plentiful – but localized – the reactivity and general suitability for use as a structural SCM is currently considered problematic. As current practical sources of SCM supply decline, it is important to invest in new, viable, at scale, replacements, looking to improve the availability of calcined clay and recycled ground limestone.

Another development being trialed as an alternative material for the manufacture of cement is the use

of construction and demolition waste (CDW). Current trials are limited via existing standards to the use of 20% CDW; however, this is likely to extend to 35% within the next year, making it a more abundant and credible alternative to the dwindling supply of GGBS/FA. The cement industry itself has recognized the importance of decarbonizing the supply side of concrete construction and the Global Cement and Concrete Association (GCCA) has recently released its industry-wide pathway to net-zero emissions by 2050.

Figure 46: GCCA Net-zero pathway<sup>19</sup>



The GCCA pathway looks to significantly improve the carbon associated with the kiln heating process (approx. 40%) as well the reaction emissions from the heated limestone itself (approx. 60%). The pathway looks in the immediate next decade to make energy efficiency gains and explore alternative non-fossil fuels in relation to the heating process and increase clinker substitution in relation to reducing reaction emissions. Overall, the pathway looks to support a reduction of 25% in CO<sub>2</sub> emissions per m<sup>3</sup> of concrete by 2030 from a 2020 base. Beyond 2030, there is a clear and growing reliance on the emergence of carbon capture, utilization and storage (CCUS) to drive to net-zero emissions by 2050.

It is important that all future projects using concrete look to support procurement aligned with this trajectory. However, the GCCA pathway also shows that over the next decade, the industry can have a significant impact by adopting better, more ambitious design and construction reductions.

Steel reinforcing bars (often around 30-40% of the overall carbon footprint of a reinforced concrete structure) can vary significantly in their reported carbon footprint. The key factor in this variance is the amount of recycled steel used and whether the smelter has used an electric arc furnace with a clean source of power to reform the steel bars.

**Typical low carbon recycled reinforcement bar = 0.76 kgCO<sub>2</sub>e/kg<sup>20</sup>**

**Typical world average reinforcement bar = 1.99 kgCO<sub>2</sub>e/kg (ICE Database 2020)<sup>21</sup>**

Although companies should recognize the benefits of using both cement replacement and the use of recycled steel at an individual building level, given the global perspective laid out above in terms of availability, they should not rely on these benefits in the place of the reduction of material use to the absolute minimum. Perhaps a better way to view the use of these decarbonization approaches should be as an effective further offset beyond realizing a minimum threshold via other reductive measures.

## Structural steel

In a similar way to reinforcing steel, individual structural steel sections can vary significantly in terms of their carbon intensity depending on geography and whether they are manufactured from scrap via an electric arc furnace process using clean energy versus a virgin ore in a blast oxygen furnace process.

The range of carbon intensity numbers can vary from around 0.75 to 2.8 kgCO<sub>2</sub>/kg steel section (A1-A3).

Once again, to support the most impactful global decarbonization an individual project should reduce consumption to an absolute minimum and then take advantage of the possibility of using lower carbon electric arc furnace recycled steel sections.

In addition to the general building form measures pointed to above, perhaps companies can drive new thinking in terms of the way they optimize steel structural frames if the primary desire is to use less steel and subsequently emit less carbon.

An example of an innovative solution to reduce carbon in the design of conventional steel composite floor plate construction is the proposal to adopt "tree columns" to effectively shorten spans. The column heads effectively shorten the spans of the main beams reducing both depth and weight. The carbon savings estimated from this simple modification to convention is in the region of 15-20% when compared to a standard floorplate system.

Figure 47: Embodied carbon of steel

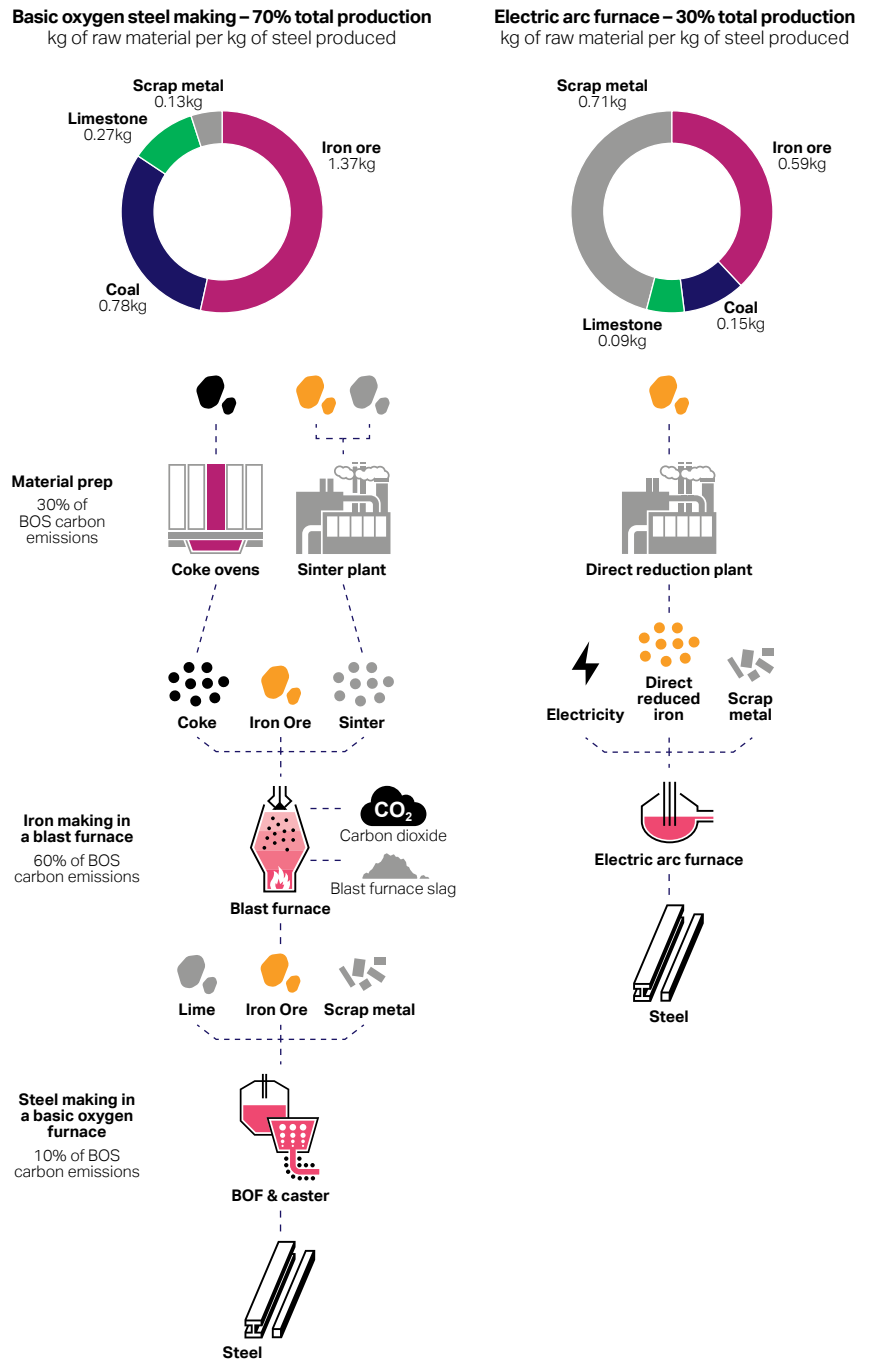
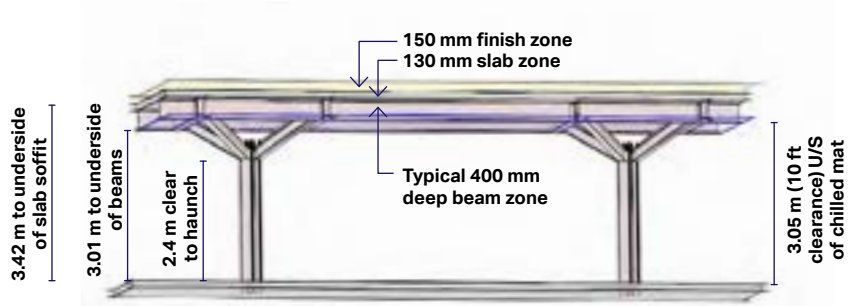


Figure 48: Tree column floor system developed by Make Architects and Arup – effectively shortening the span



## Engineered timber

Used in the right way, modern engineered timber (glued-laminated timber sections [GLT], cross laminated timber sheets [CLT] and laminated veneer lumber [LVL] primarily) can contribute significantly to lowering the embodied carbon footprint of a building structure. In essence the reduction is delivered via the engineered timber generally being a low-carbon intensity product, as compared to steel and concrete alternatives, and via the sequestration (storage) of the equivalent carbon once a replacement tree has grown in place of the timber used, assuming sustainable, certified, forest

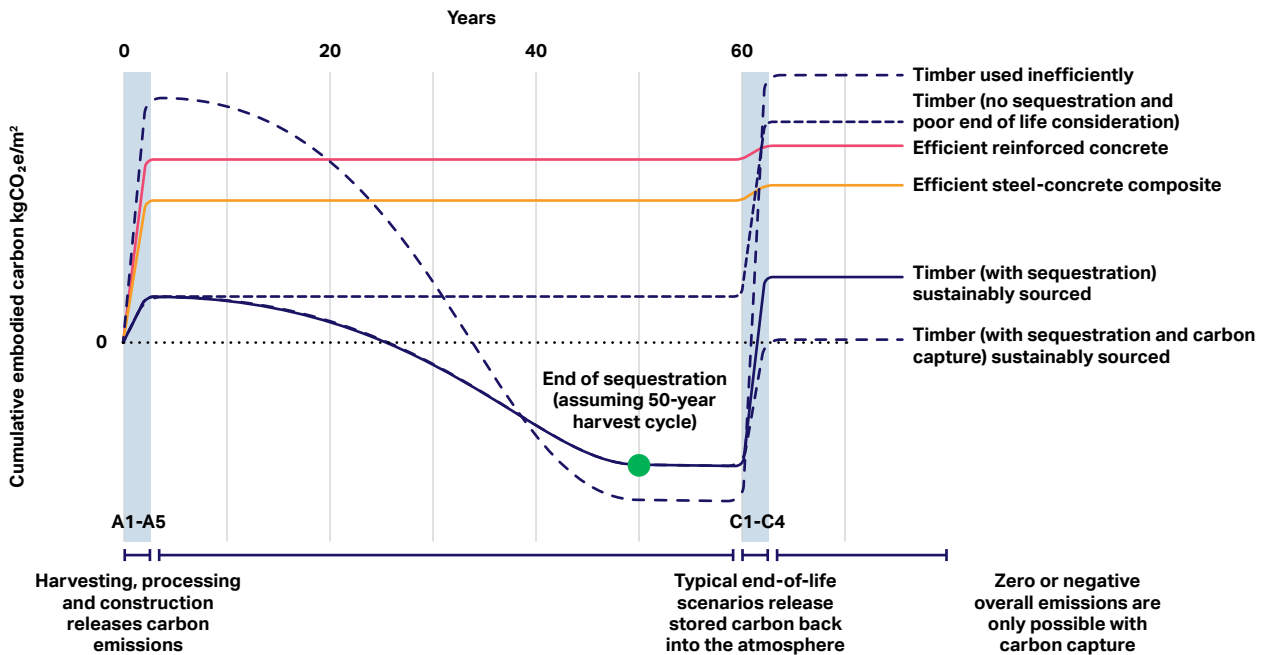
management schemes are in place. The sequestration occurs over an effective period, as a new tree must mature in place of the used timber and is ultimately negated at the end of life if the timber is burnt or worse still put into landfill where it can release methane, an even more impactful greenhouse gas. Companies should consider how they will repurpose or recycle timber components at their end of life as part of designing in timber to ensure it achieves its maximum sequestration potential.

As an example, the Haugen Pavilion, a two-storey building in Stratford, London, achieves an upfront embodied carbon outcome for the whole structure without assuming sequestration of  $210 \text{ kgCO}_2\text{e/m}^2$  (note if considering the mass timber frame only, it would be  $80 \text{ kgCO}_2\text{e/m}^2$ ) and a carbon storage potential assuming sequestration of carbon over its deemed life span of  $240 \text{ kgCO}_2\text{e/m}^2$ . Hence, if companies can justify the indefinite carbon storage via verified end-of-life considerations, they can get to a net negative overall structure with well-designed timber buildings.

**Figure 49:** Haugen Pavilion in Stratford, London demonstrating mass timber construction



**Figure 50:** Comparison of good and bad timber use<sup>22</sup>



Engineered timber used inefficiently, for example where significantly more material than necessary is required for a particular design application or significant additional measures to deal with issues such as robustness, stability, fire and acoustics are required, can be worse than using more conventional steel and concrete systems.

Even if global engineered timber production doubles in the next decade to 8 million m<sup>3</sup> in the context of driving a halving of upfront embodied carbon by 2030, considered globally, engineered timber is a relatively rare construction commodity so should be used to its greatest effect in relation to global emissions reductions.

**Figure 51:** Is super high-rise construction an efficient use of global engineered timber supply?



## Hybrid construction

Using materials in combination to gain the best overall outcome in terms of embodied carbon and potential sequestration benefits has a lot of potential. In a hybrid structure, companies can deploy different materials more to their optimum performance. For example, they can use steel or concrete primary frames and stability systems effectively with CLT decking, ensuring the timber deployed is kept in its most reusable condition and hence sequestration can be considered appropriate, while the fire and acoustic issues associated with all timber construction are easily dealt with without the addition of further systems.

Figure 52: CLT concrete hybrid floorplate system

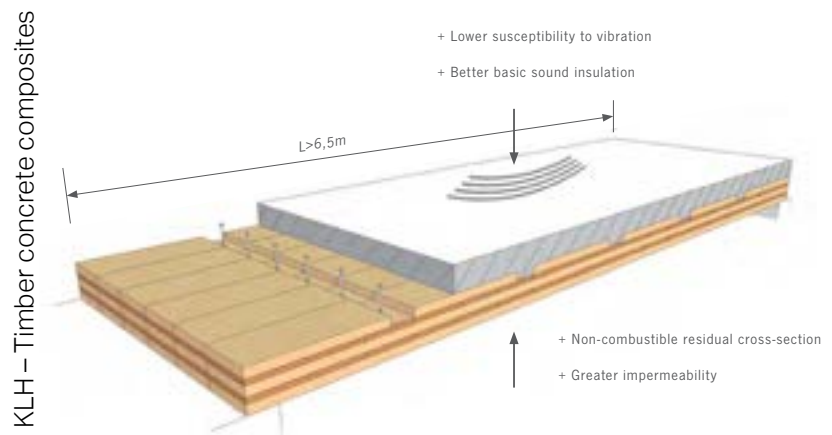
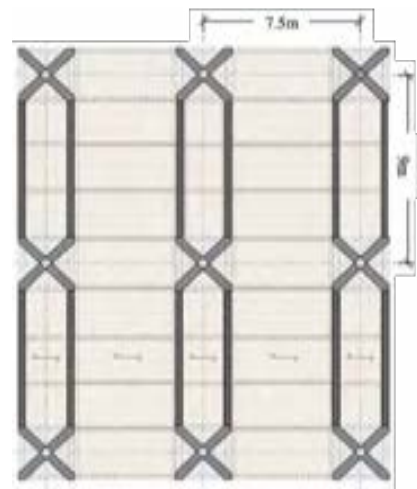


Figure 53: Hybrid reinforced concrete and timber frame proposal for an office building in London



### Emerging low-carbon alternatives

Given the amount of time taken for new technologies to become mainstay construction techniques, companies cannot rely on the emergence of new materials that can be deployed at a global built environment scale over the coming decade. For the ones already established, they can be niche and the challenge sits with their scalability. There are also some encouraging signs that more innovative new low-carbon intensity materials may emerge in the not-too-distant future. More research, innovation and investment are clearly required to develop genuine scalable alternatives to steel and concrete in the next few decades.

Figure 54: Example of hempcrete house



Figure 55: Example of rammed earth wall



## New forms of construction

The construction industry by its nature is conservative and relies heavily on precedents. Relatively low profit margins drive this, which in turn drives poor levels of investment in developing new ideas. Companies are, for all intents and purposes, constructing buildings using the same structural techniques and systems that they have used for decades. Perhaps to meet the challenge of halving carbon emissions, companies need to drive a higher level of innovative new thinking in terms of the structural systems they design. Companies need to

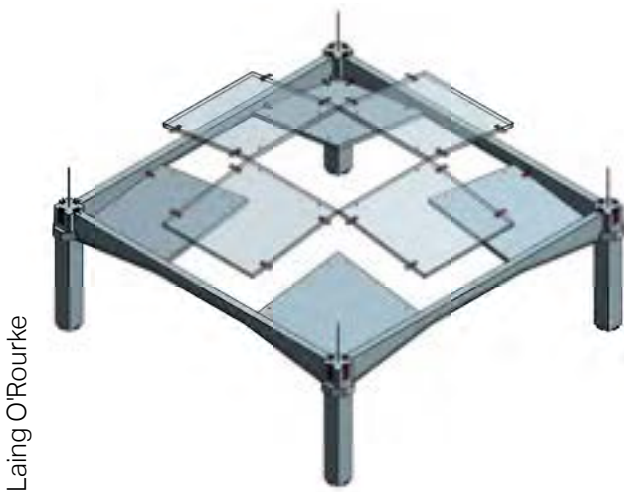
rethink preconceived concepts and systems from a carbon perspective and re-engineer them looking at the new imperative of optimizing the carbon footprint while still delivering the required function.

One example of this is a recent piece of work undertaken to look at how to reimagine a 9x9 meter standard reinforced concrete floor plate starting from the position of minimizing material consumption and hence carbon. The proposal is for a vaulted system instead of adopting a planar concrete slab surface. The vaulted slab uses compression as opposed to

bending action to resist the floor loads and as such is a much more materially efficient structure, a principle understood for millennia but disregarded as other influences took precedence over material efficiency in design.

As companies explore new ideas, preconceived norms will push back against them. But companies must strive to overcome all barriers that arise. If companies rapidly, and holistically, collaborate to evolve new ideas, a whole new generation of low-carbon solutions outside of preconceptions will emerge.

**Figure 56:** Prototype of a precast vaulted floor plate – Laing O'Rourke – Arup (approximately 1/3 of the CO<sub>2</sub>e of a more conventional flat slab).



Laing O'Rourke

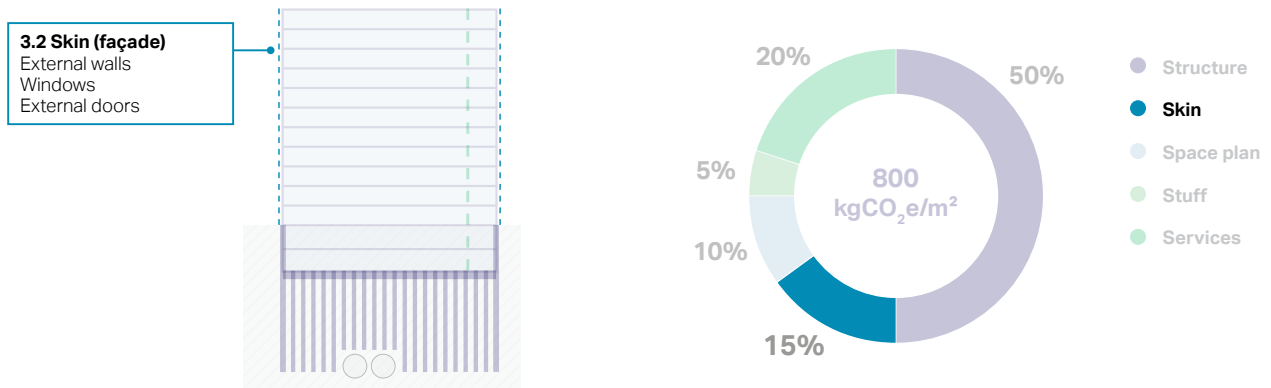
**Figure 57:** EMPA-ETH Zurich HiLo vaulted flooring system





## 2 – Skin (façade)

Figure 58: Skin and upfront embodied carbon (A1-A5) estimated typical distribution

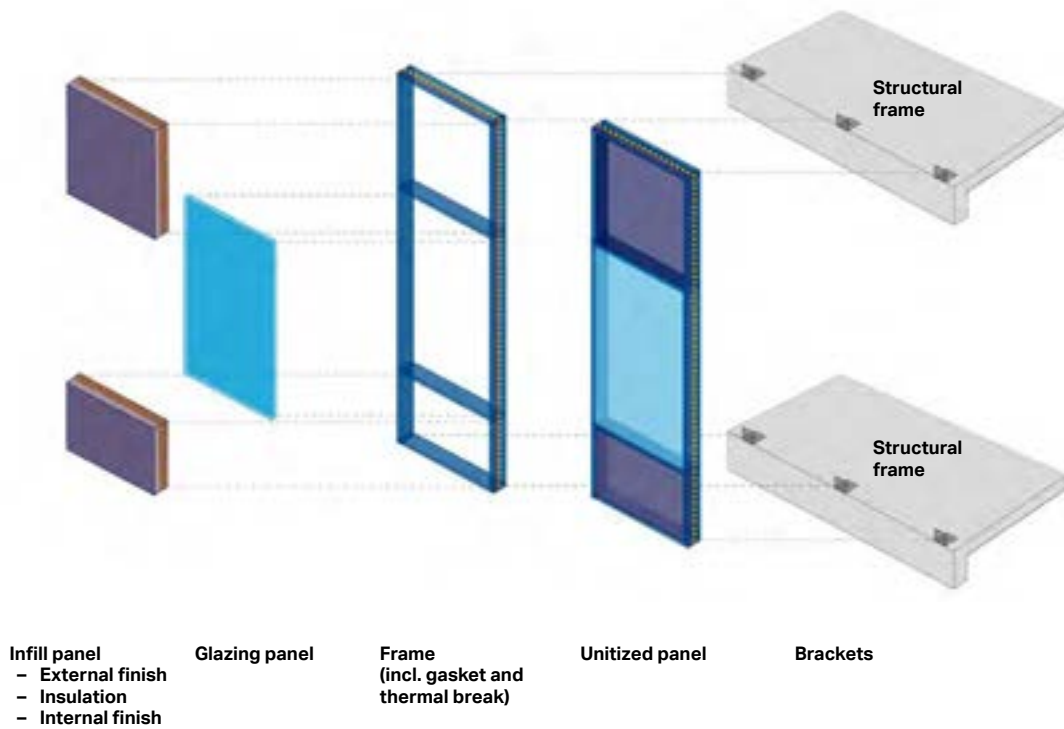


### How do we halve construction emissions?

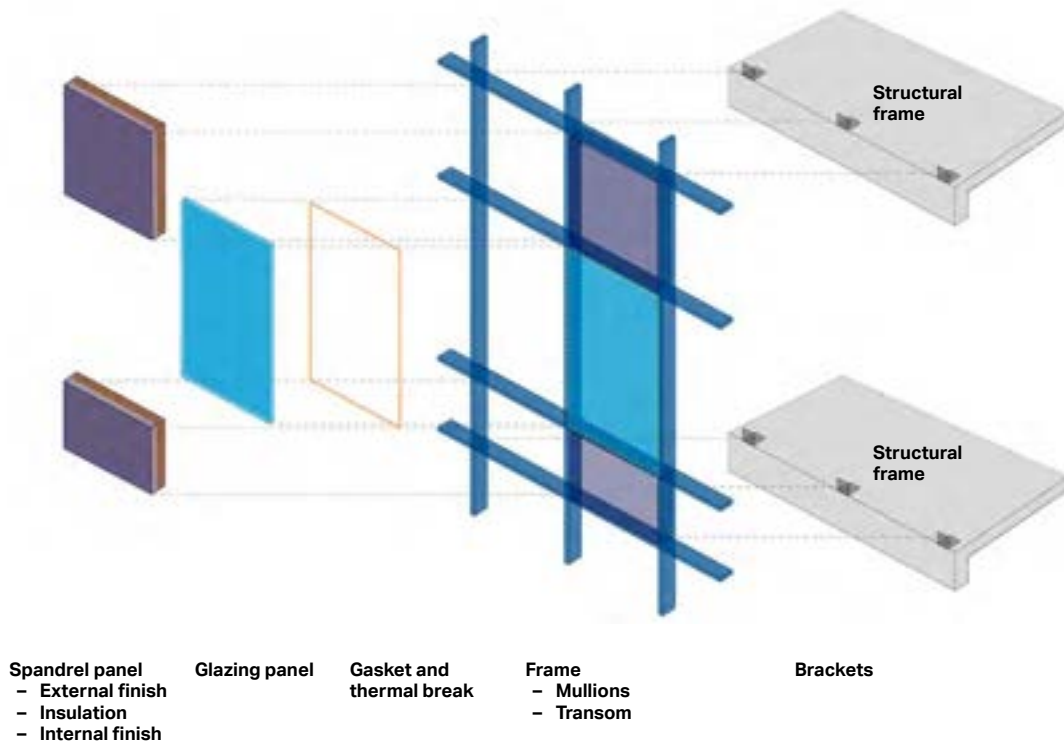
Although the façade designs can vary significantly based on the type of system adopted and performance requirements sought, upfront embodied carbon average per square metre of façade area from experience across a wide number of measured projects might be considered typically in the range of 150-300 kgCO<sub>2</sub>e/m<sup>2</sup> when applied to the surface area.



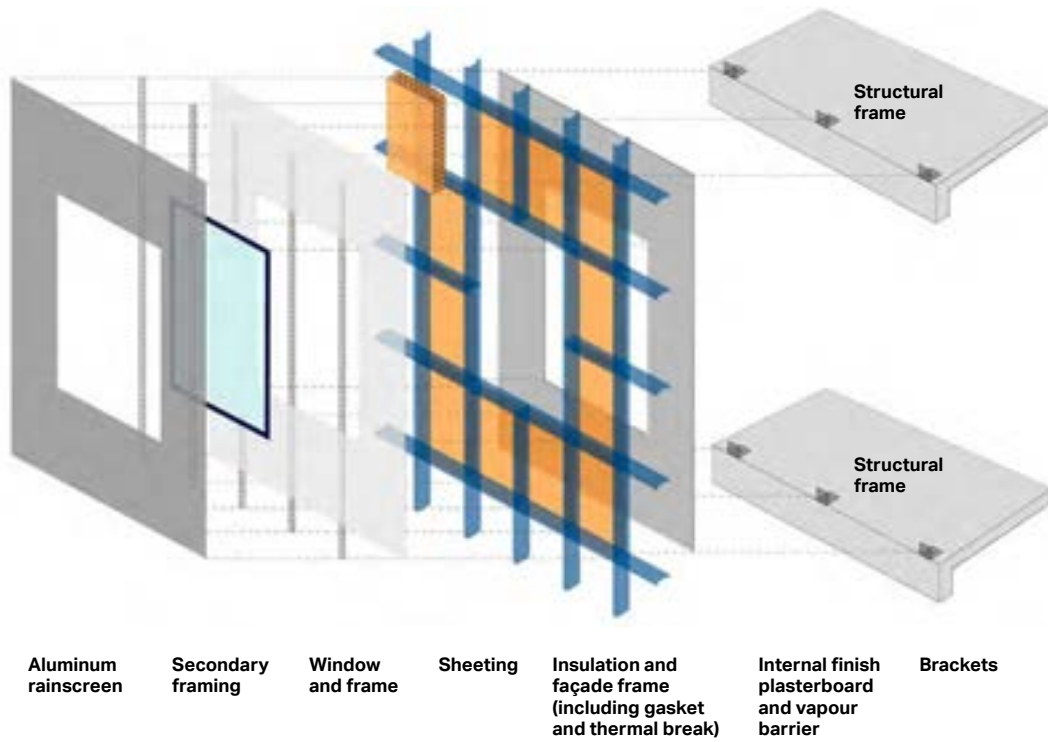
**Figure 59:** Aluminum unitized curtain wall (WT-02)



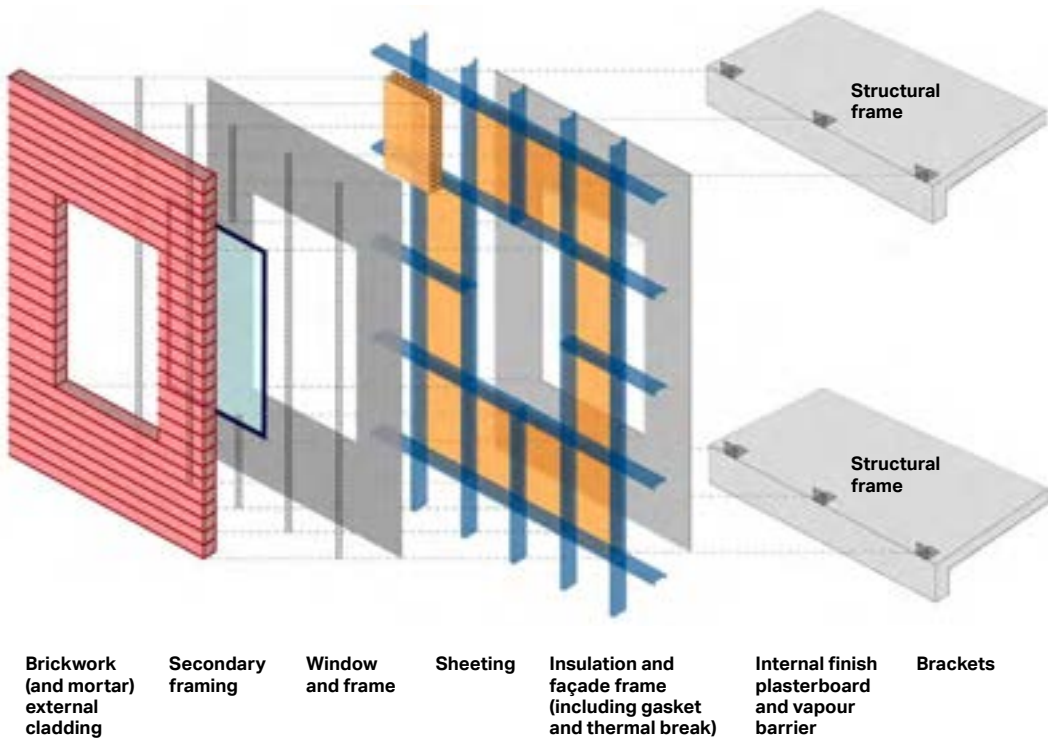
**Figure 60:** Steel stick system curtain wall (WT-08)



**Figure 61:** Aluminum rainscreen, steel frame panel (WT-13)



**Figure 62:** Brickwork masonry wall – steel frame system (WT-15)



As can be seen from Figure 63, breaking down four common façade types (figs 59-62) the most impactful elements of the façade in relation to upfront embodied carbon are typically the metal framing, the glass and external finishes and shading applications.

The previous **Where do we stand?** report concludes that, across the 6 case studies, the façade contributed on average to 15% of the upfront embodied carbon of a building (A1-A5) and on average around 20% of the embodied whole life carbon (A-C). One individual case had a maximum façade contribution of around 30% of the whole life-cycle embodied carbon (A-C), which in turn equated to over 20% of the total whole life carbon. Hence the contribution of the façade system is of significance and companies should consider it carefully at the outset.

Façades both contribute directly to the embodied carbon of a building and have an influence on its

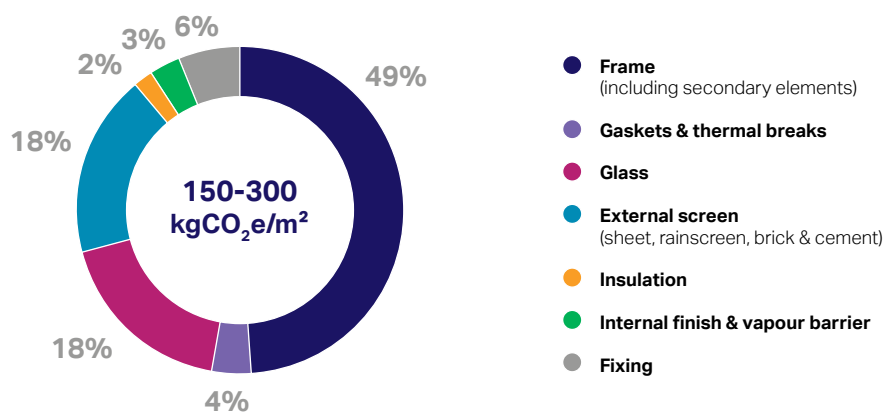
operational carbon. Although there has been widespread focus and legislation on reducing operational energy use, and hence operational carbon, there has been little global focus on the embodied carbon contained within the façades of buildings. In some localized regions the awareness of embodied carbon benchmarks and targets to focus the industry on embodied carbon reduction is only just now emerging.

Façade systems, although not typically consuming operational energy, through their design can increase or decrease a building's operational energy and associated carbon via their performance. It is necessary to assess the relationship between embodied and operational carbon impacts during the development of the façade design, for example the addition of significant carbon-intensive shading elements (e.g., aluminum bris Soleil) can, if not considered carefully, lead to a major increase in the total embodied carbon that,

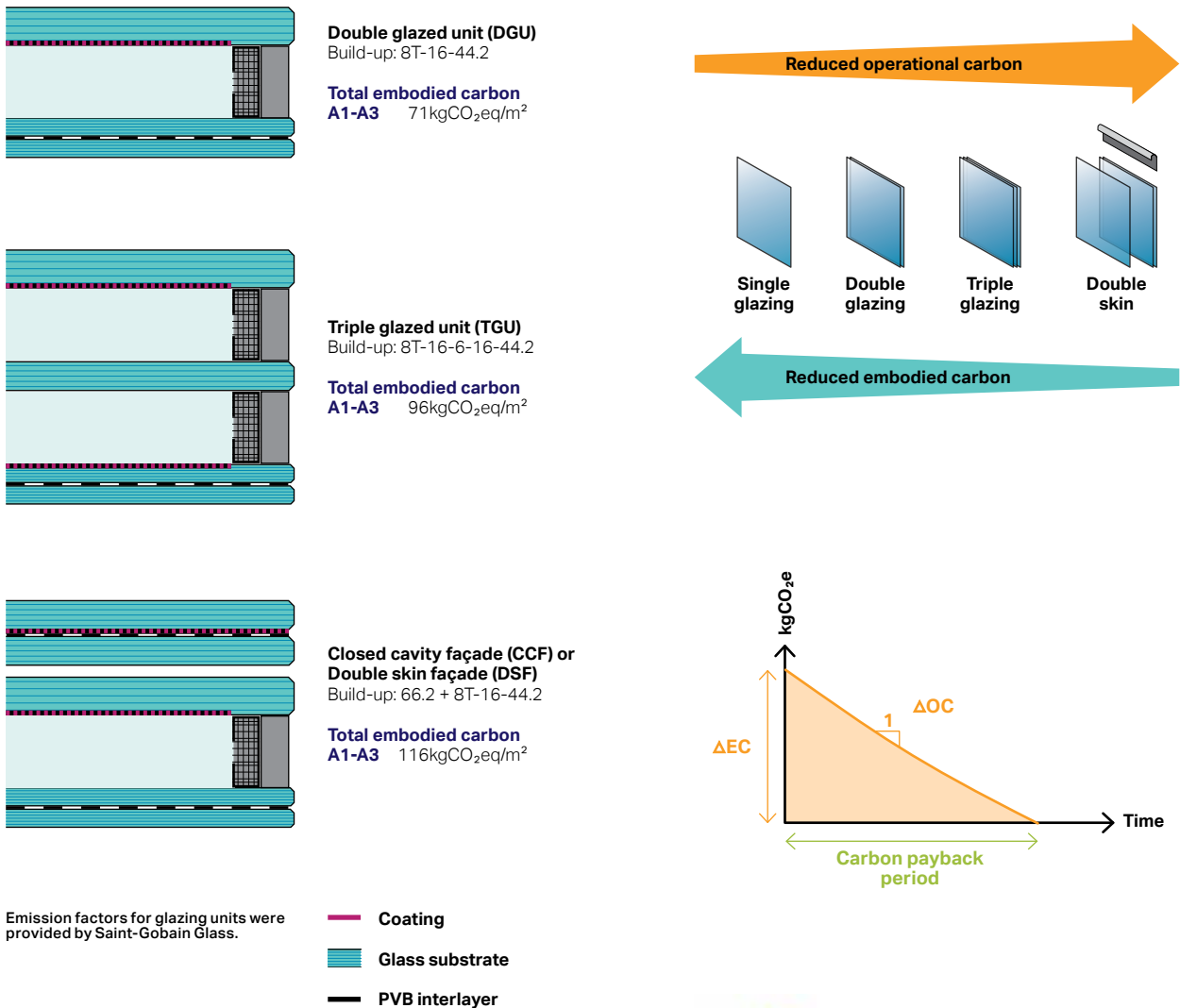
in some cases, improvements in operational energy performance do not pay back. Understanding the relationship between embodied carbon of the skin and operational performance of the building (services layer) is key to making deliberate, carbon-conscious decisions to reduce emissions across supply chains and design processes.

The operational performance of façades is related to their orientation and the azimuth of the sun. Companies should develop their design to their specific exposure condition on the building, bringing an opportunity to further tune the relationship between embodied carbon and operational performance.

**Figure 63:** A1-A3 average contribution of façade components over 4 façade typologies

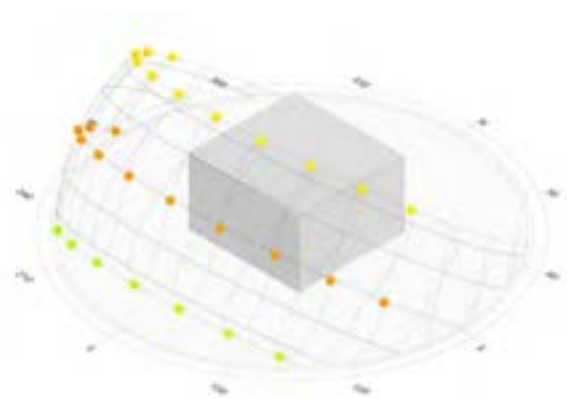


**Figure 64:** Diagram showing example of payback period study comparing double and triple glazed units.



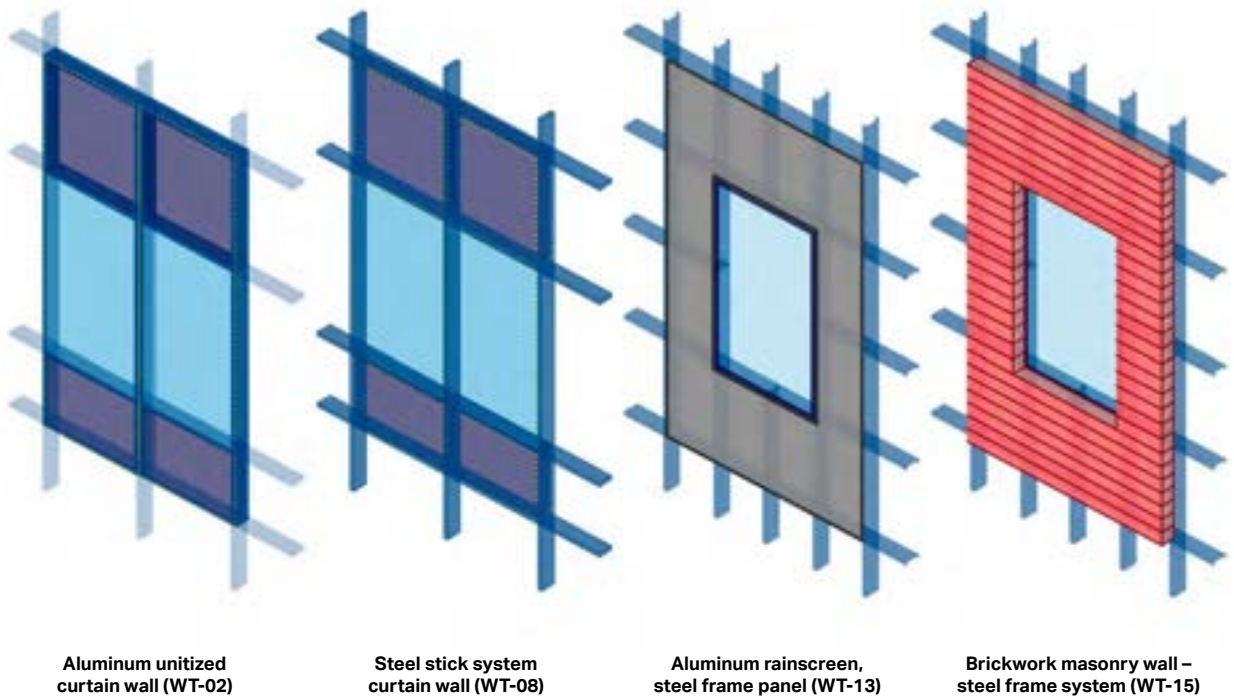
The comparison of carbon data related to the building skin, across multiple projects, is challenging as design decisions respond to a wide range of drivers, parameters and performance requirements that make each combination unique. It is also necessary to consider the façade in terms of its effect on the embodied carbon of other building layers as decisions made can have an impact on other building layers. For example, the skin layer is closely related to structural layer movements; if the façade is heavy or brittle it may require the use of more material in the structure that supports it. It is important

that companies understand the actual impacts of these wider holistic building layer decisions and consider them in terms of making the best overall outcomes.



**Azimuth of the sun as a design consideration**

**Figure 65:** Façade typologies

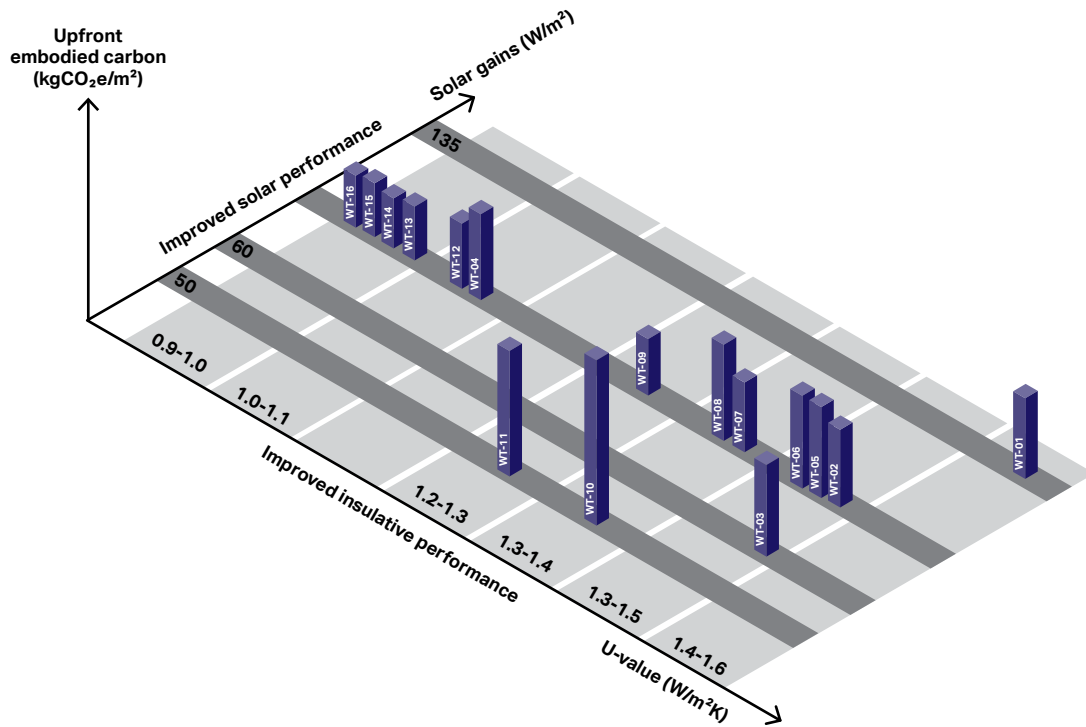


To answer the question of **“How do we halve construction emissions?”** holistically, companies need to look across building layers and across carbon stages (embodied and operational). Holistic payback studies assessing at what point in time the operational savings in the building services will offset the upfront carbon cost of a performance improvement to the skin is a good example of this holistic approach. Examples of these studies are currently not widely available, do not follow a consistent methodology and will be unique to

each skin-building combination. However, from what companies have studied to date, there are some emerging general trends to explore with regards minimizing the initial upfront embodied carbon of façade designs.

Figure 66 taken from a sample of 16 façade projects shows a wide range of operational performance outcomes (x and y axis) linked to non-corellating embodied carbon outcomes (z axis), suggesting these two carbon performance criteria are not currently considered together.

**Figure 66:** Embodied carbon figures alongside thermal and solar performance



### Overview of cladding systems and associated embodied carbon

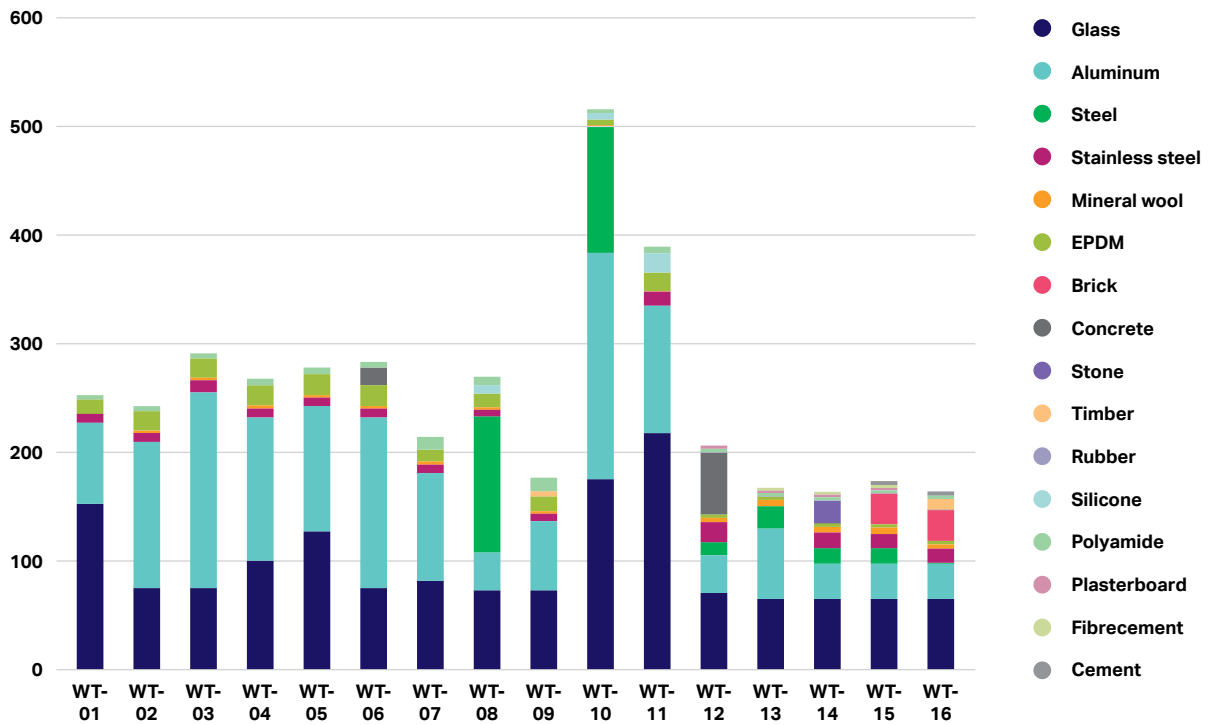
Generally, façades are made up of a variety of systems, configurations and materials from a broad supply chain. The lack of information about the full material journey, together with the lack of an industry-wide façades methodology to calculate embodied carbon, makes comparison across sources a challenging exercise. Hence there is an urgent need for better, consistent façade system carbon data within the industry.

Recent research from Arup and Saint-Gobain<sup>22</sup> used detailed analysis to enable a comparison of popular cladding types for a range of key materials and design parameters. Some of the key findings were:

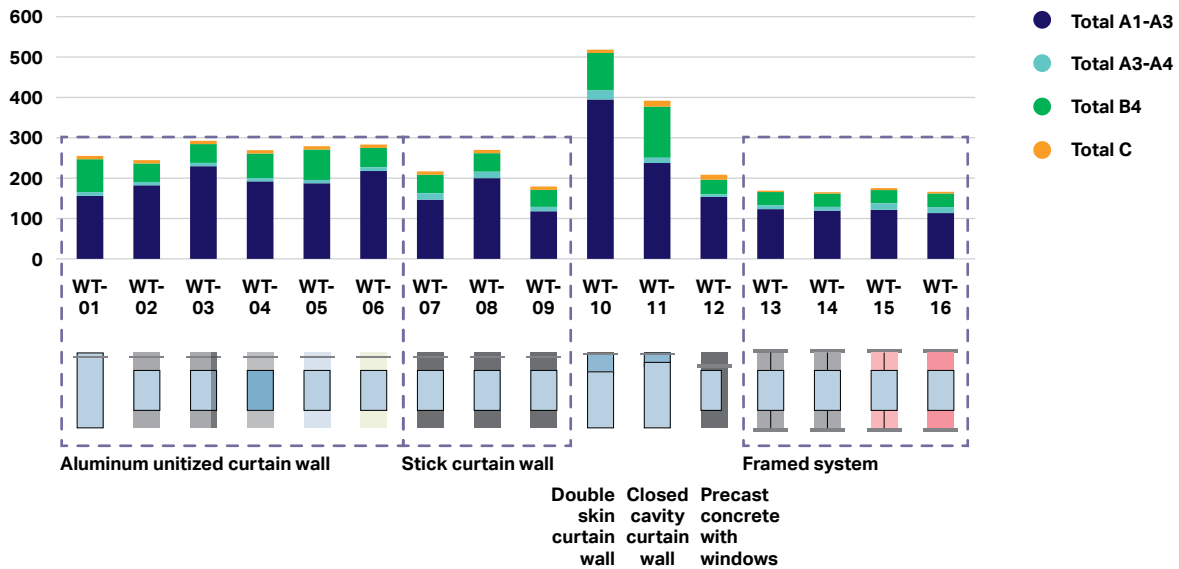
- Embodied carbon (A1 – A5, B4 and C1 – C4) ranged from **160 to 520 kgCO<sub>2</sub>e/m<sup>2</sup> of façade area** (significant variance depending on the system type and design).
- Often, from a material perspective **aluminum** is contributing to embodied carbon as much or closely followed by **glass**.

- Limited service-life of key materials and components means they may need replacing two or three times over the typical life expectancy of a building (e.g., insulated glazed units that may only have a useful service life of 25 years). This is a significant additional embodied carbon burden if not carefully considered as part of a deliberate circular economy life cycle from the outset.

**Figure 67:** Example of embodied carbon/m<sup>2</sup> comparison of some typical façade types – Arup and Saint-Gobain Study 2022.<sup>23</sup>



**Figure 68:** Diagram showing average embodied carbon distribution across WLC stages





**Design variables of significant impact**

The Arup and Saint-Gobain study took 16 curtain wall system types, typical of modern residential and commercial buildings, and investigated the influence of key design and material decisions by analyzing the data from thousands of façade configurations and corresponding energy simulations across the 16 typologies. It explored insights such as the influence of the window-wall ratio, the bay size and solar control products.

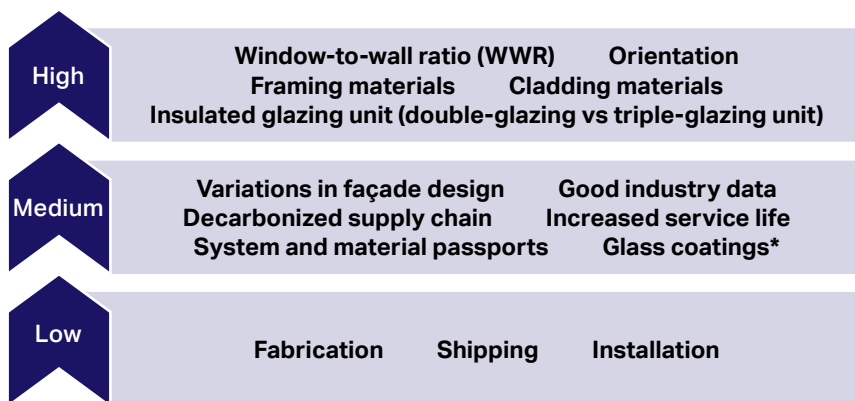
Although the correlation between parameters in the study did not point at universal conclusions, some clear insights on carbon drivers emerged from the study:

- Window-to-wall ratio (WWR): ~80% variation in embodied carbon, with a big impact on operational carbon (i.e. U-value, solar gains)
- Framing materials: ~40% variation in embodied carbon (industry average, highly sensitive to supply chain)

- Cladding materials: ~30% variation in embodied carbon (industry average, highly sensitive to supply chain)
- Insulated glazing unit (double glazing [DGU] vs triple glazing [TGU]): ~10 % variation in embodied carbon (depends on WWR), with impact on operational carbon (i.e. U-value)

Other trends and guidance on achieving lower carbon façade design also emerged from the study:

**Figure 69:** Key considerations in low-carbon skin design



\*Application of glass coatings improves operational performance at a minimal embodied carbon cost

Consideration of the above from the earliest opportunity should allow for considerable scope to make better decisions in terms of driving much lower upfront embodied carbon designs.



## Plan for low carbon from the start

Referencing the discussion above, low-carbon façades require good early understanding by all stakeholders in the design process to have the maximum overall impact. Companies should explore all ways to achieve the project's overall aims fully at the outset. For instance, is new construction the best answer, can a refurbished façade facilitate the reuse of an existing building and deliver the required energy performance?

Each project should look to set clear implementable targets with respect to the skin building layer

(façade) that consider the basic overall relationship between the key drivers. Companies should consider project parameters such as the orientation, required service life, expected use conditions, building form factor, climate resilience measures, thermal performance and mass, future flexibility, access requirements, façade system selection, coordination and optimization with the structure and mechanical systems and other functional requirements (architecture, acoustic, security, fire etc.) as holistically as possible at the earliest stage. **At all points, they should review and consider the carbon payback period.**

Façades are typically relatively complex systems of materials, and the emergence of clear **environmental product declaration (EPD)** documentation throughout the supply chain will help to drive transparency and demand for lower carbon designs within the industry.

Designing out waste, maximizing off-site manufacture and minimizing weight are all ways to reduce the overall embodied carbon impact.

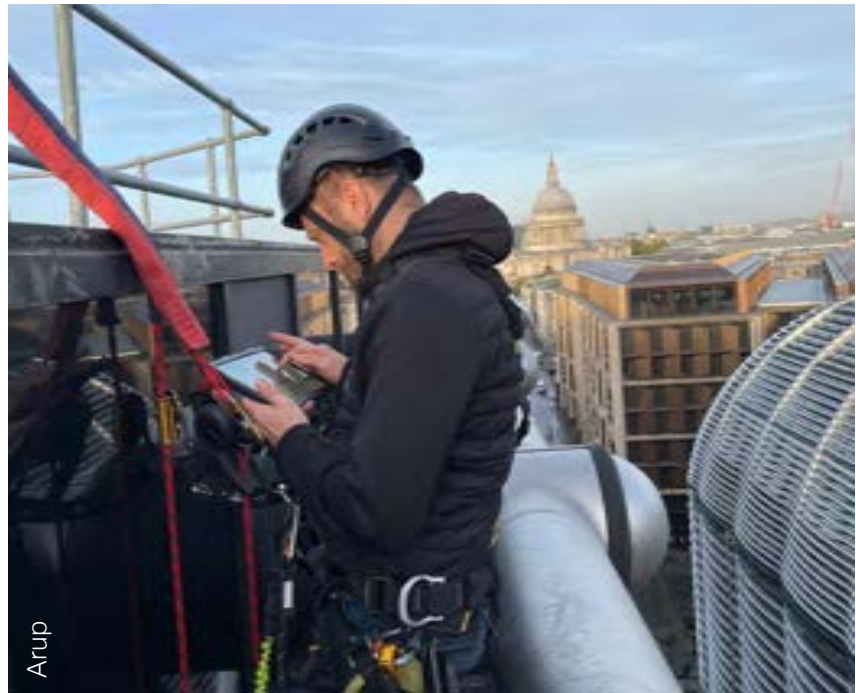
**Figure 70:** Triton Square, London – 3,000m<sup>2</sup> of façade taken down and refurbished locally to improved performance criteria



Companies should consider the impact on embodied carbon of all visual requirements of the façade system in relation to their carbon impact. For example, allowing a reduced finish quality on less visually prominent areas of the façade and relaxing glazing distortion limits and color variance requirements can reduce the energy and the embodied carbon associated with rejected waste material.

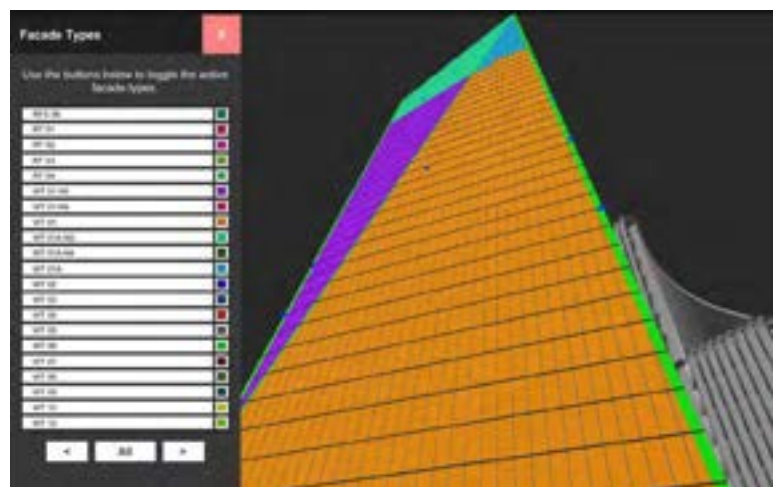
Companies should carefully consider the ease of access to parts of the façade that need to be more regularly inspected, cleaned, maintained and replaced. They should account for the carbon impact of the cleaning requirements of a façade in the project-wide embodied carbon assessment. Designers should consider if they can reduce the cleaning procedure to decrease the carbon emissions associated with the maintenance or if more frequent, targeted cleaning might enable materials, components and systems to have significant extra life and thereby reduce the additional embodied carbon associated with replacement.

**Figure 71:** Façade inspection and maintenance considered from the outset



Accurate, accessible and structured as-built information, including detailed records of materials (digital twin) is fundamental to realizing future refurbishment options, reuse potential and recycling capabilities of a project.

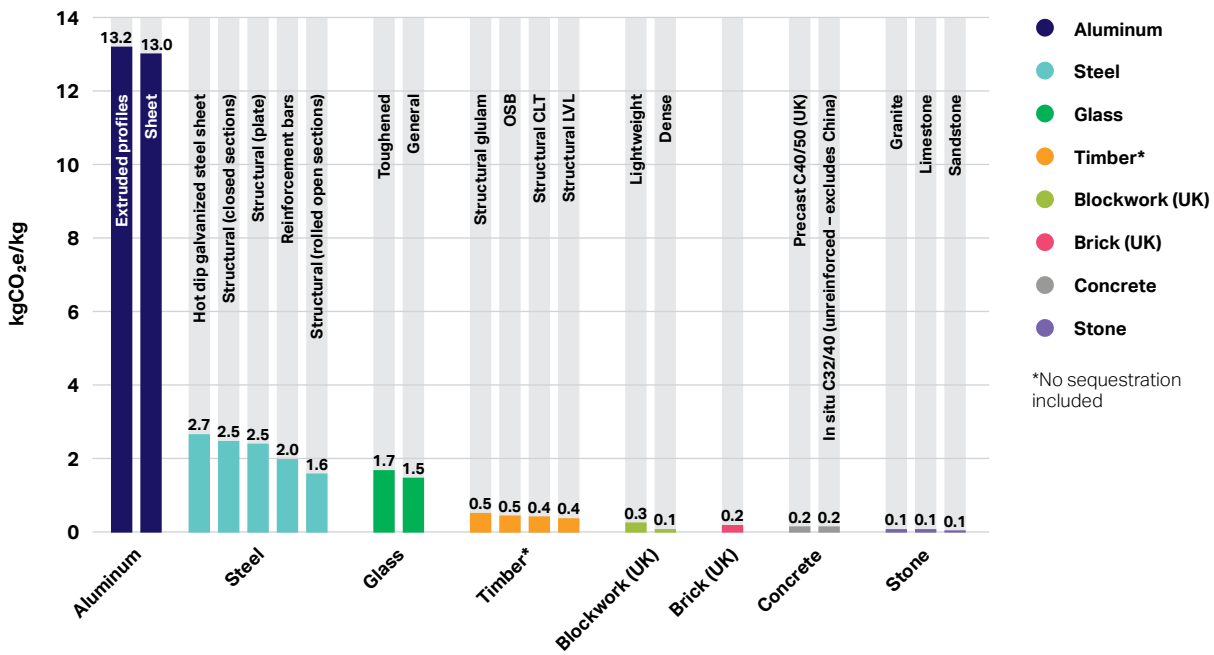
**Figure 72:** Façade virtual twin



## Material choices

As already demonstrated, material selection and its supply chain have a significant impact on the embodied carbon that goes into the skin of a building. Designers should pay particular attention to the components and materials with the highest impact.

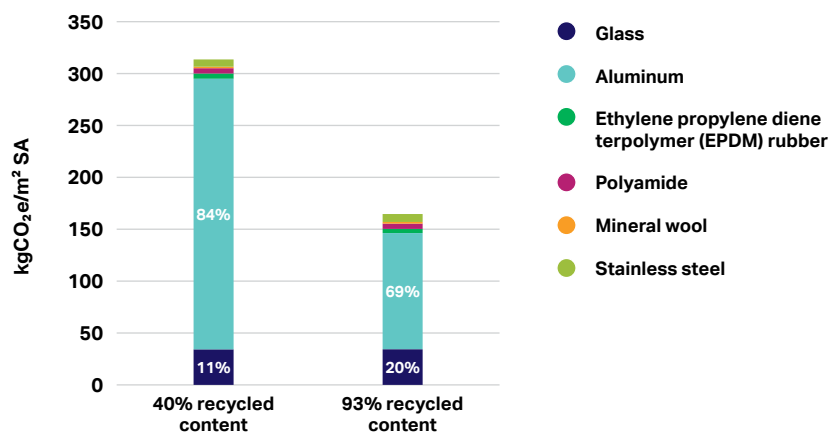
**Figure 73:** Carbon intensity of all materials considered in façades



## Supply chain

Many players within material supply chains are beginning to focus on trying to decarbonize their production. One example of this is the aluminum market. By increasing the recycled content of aluminum and using renewable energy supplies in production, it is possible to dramatically reduce the embodied carbon. The supply chain choice for this single material alone can halve the embodied carbon of a typical curtain wall.

**Figure 74:** Potential range of typical aluminum unitized curtain wall

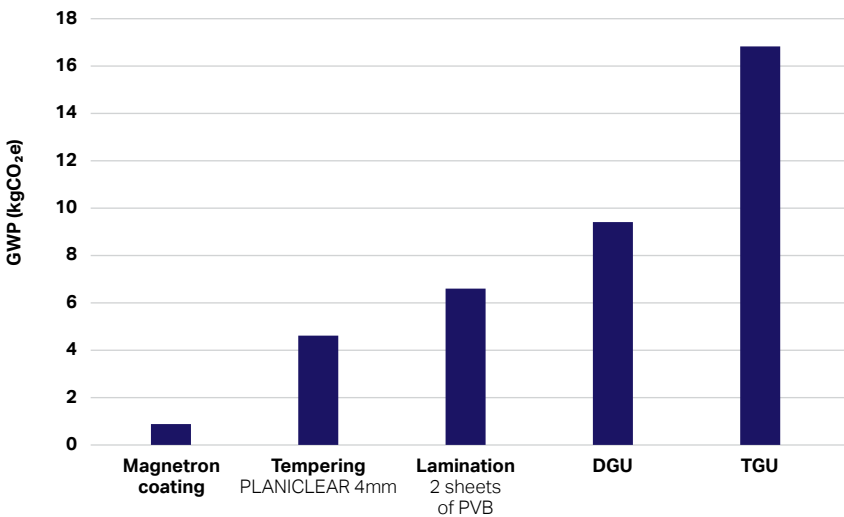


At current rates of aluminum scrap recycling versus global demand, companies should bear in mind that like the steel industry, the scrap market can only supply to approximately a third of demand. Hence, there should always be a drive to reduce consumption to an absolute minimum before relying on recycled content to reduce the overall embodied carbon footprint of the façade.

Glass manufacturers are also looking to develop lower carbon products via the use of significantly increased amounts of cullet (recycled glass) combined with the use of renewable electricity within their process to produce equivalent technical and aesthetic performance to conventional glazing products.

Some materials and processes can have a significant impact in reducing the whole life carbon (WLC) of the façades by extending service life or offering operational savings with minimum upfront carbon cost. A clear example of the latter are glass coatings, where an additional 1 kgCO<sub>2</sub>e (~2% of the carbon cost of a typical double glazing), can save ~10 KgCO<sub>2</sub>e/m<sup>2</sup> of façade each year.

**Figure 75:** Embodied carbon involved in common glass processes



**Figure 76:** Glass being recycled into cullet



## Emerging low-carbon alternatives

Designers are exploring many experimental low-carbon materials, some of which have a history in building construction prior to modern architecture. These include “biogenic” materials originating from plant or animal sources available in the biosphere, naturally occurring geological materials and composites of the two. In applications generally within the less-regulated parts of the construction industry, these experimental alternatives to current convention are demonstrating potential to create building skins or façades with significantly reduced upfront embodied carbon.

The question is whether some of these alternatives can achieve the scale needed to address global demand in the short time frames required.

It is worth noting that WLC data is often limited for these alternative materials and companies should assess each building or refurbishment for material selection on an individual basis, in that the examples outlined below will not always be the most low-carbon option – both solely in terms of up-front embodied and overall, when also considering operational performance. See section 4 and figure 99 where the “balance point” between embodied and operational carbon is discussed.

Another notable development in the façade industry is the growth of building integrated photovoltaic (BIVP) modules. The emergence and improved performance of BIVPs allows the potential for the building skin, if orientated well, to generate significant amounts of clean energy. Perhaps in the future combined with other measures above, it could lead to the façade system to potentially be a net-positive building layer over its life span.

Figure 77: Example of hempcrete



Figure 78: Bricks made from up-cycled construction waste and a lower temperature firing process



Figure 79: Bio-based cement tiles made from approx. 85% aggregate combined with 15% biocement.



Figure 80: Example of building-integrated photovoltaics



## The use of timber and other combustible materials

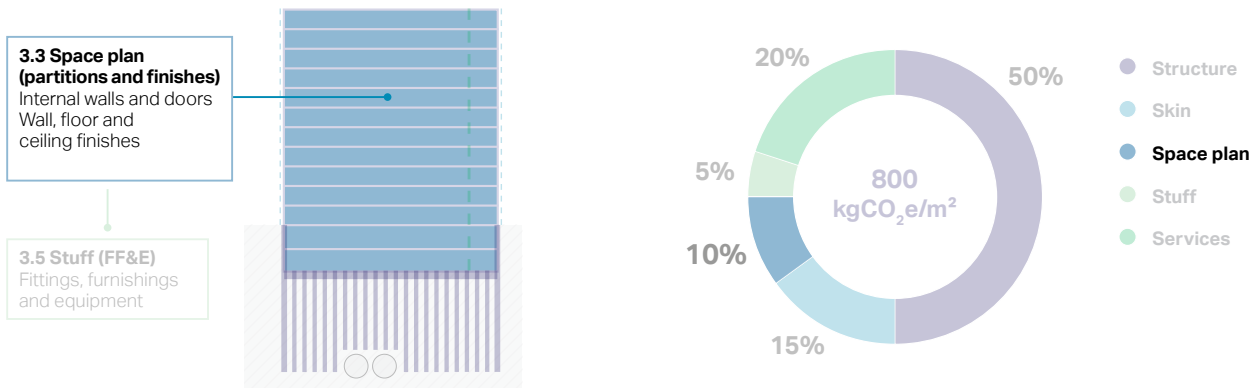
From an embodied carbon perspective, timber offers potential in terms of reducing the impact of some of the more carbon-intensive façade framing and finishes. However, designers need to carefully consider the use of combustible materials in façades. In some applications and geographies it is restricted.

**Figure 81:** Example of timber façade construction in London



### 3 – Space plan

Figure 82: Space plan and upfront embodied carbon (A1-A5) estimated typical distribution



#### How do we halve construction emissions?

As defined in our previous work, which adopted the WBCSD **Building System Carbon Framework**, space plans consist of internal walls and partitions and internal finishes, the breakdown of which we illustrate below.

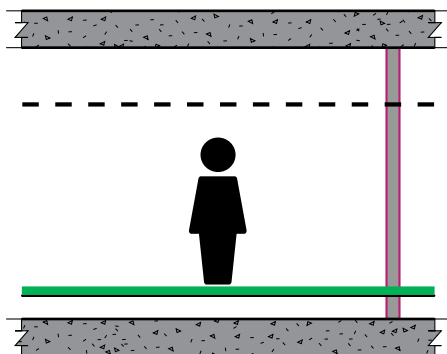
Overall, space plan elements can account for approximately 10% of the upfront embodied carbon (A1-A5) emissions of new commercial buildings, according to analysis carried out by Arup.<sup>23</sup>

However, the contribution is expected to vary significantly due to the often bespoke and variable nature of the space plan. Considering the target discussed in section 3 to limit the total A1-A5 emissions of a commercial building to <400 kgCO<sub>2</sub>e/m<sup>2</sup>, this might translate into an immediate space plan target of <40 kgCO<sub>2</sub>e/m<sup>2</sup> or less.

Figure 77 illustrates the estimated upfront embodied carbon footprint of space plan elements for three scenarios:

- A typical current commercial building – one that includes a demountable suspended ceiling and traditional raised access floors;
- A more environmentally focused current commercial building based on case studies 2 and 3 from our previous Net-Zero Buildings: Where do we stand? report;
- An aspirational target for a commercial building in 2030.

Figure 83: The estimated upfront embodied carbon footprint of Space Plan elements per Gross Internal Area (GIA) for a commercial building



	2020 typical values	2020 best in class	2030 aspirational target
<b>kg CO<sub>2</sub>/m<sup>2</sup> GIA (A1-A5)</b>			
Concrete slab			
Suspended ceiling	40	1	1
Ceiling finishes		<1	<1
Wall finishes	5	1	1
Internal walls and partitions	10	10	5
Internal doors	10	1	1
Floor finishes	10	10	10
Raised access floor	40	30	20
Concrete slab			
	<b>120</b>	<b>50</b>	<b>40</b>



A significant proportion of the embodied carbon emissions in the space plan come from raised access floors and suspended ceilings. Reducing the embodied emissions of these elements has a large impact on the overall carbon footprint of the space plan when comparing the cases above.

It is worth noting here that in some geographies it is common to have densely arranged internal walls and partitions. In these cases, the internal walls and partitions would contribute a significantly greater proportion of the space plan carbon footprint.

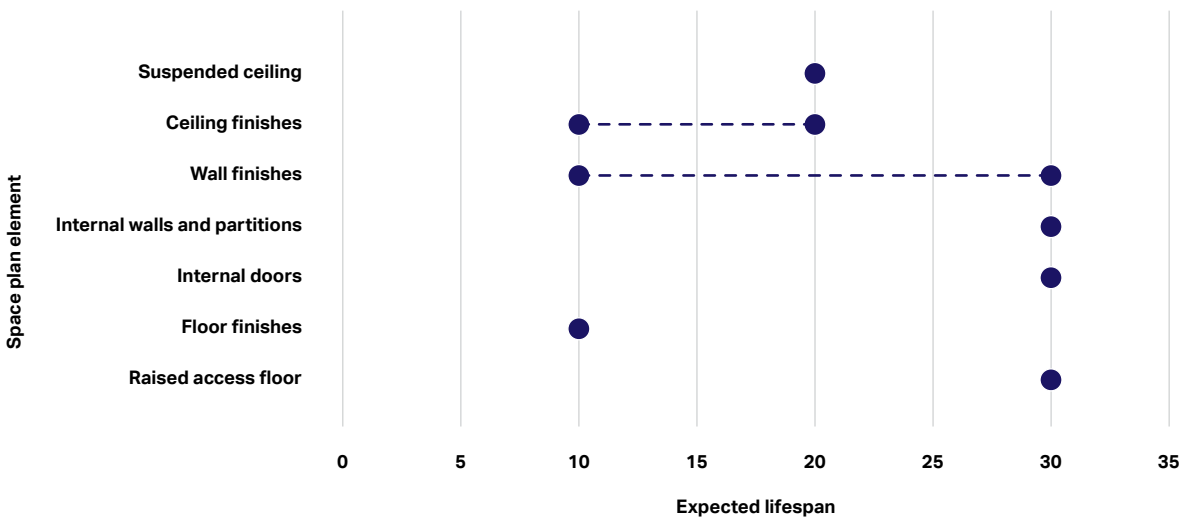
The above 2030 target case aims to illustrate further possible savings to achieve the  $<40 \text{ kgCO}_2\text{e/m}^2$  gross internal area (GIA) target for the space plan.

In addition to the upfront, product and construction stage emissions (A), the Space Plan elements outlined above generally need to be upgraded or replaced during the lifetime of buildings, generating additional emissions during the use phase (B). The lifespan of typical finishes tends to be around 10-30 years while that of partitions is generally about 30 years, hence all elements of the space plan are expected to be replaced at least once during the defined 60-year lifetime of a building. Architectural and commercial trends drive replacement but the durability of the materials chosen also influences it since the space plan elements are often those in direct contact with the building users.

Given the above life span and replacement periods, it is important that companies also consider circularity (repurposing, reuse) as well as carbon in the determination of the space plan design. As adopting a non-circular, business-as-usual scenario companies could in theory create a space plan life-cycle design that produced in excess of  $300 \text{ kgCO}_2\text{e/m}^2$  if companies replaced everything with no recycling consideration

We discuss the most effective methods of reducing emissions from these elements of the space plan in the following sections.

**Figure 84:** Typical life span assumptions



## Reducing resource consumption

The biggest opportunities to remove embodied carbon comes from reducing resource consumption.

### Omitting

- **Suspended ceilings**  
Building services systems are designed to be visibly exposed.
- **Raised access floors**  
Electrical and communication cables, small ducts and other floor mounted building services systems are integrated into other finishes or designed to be surface mounted.
- **Non-structural internal walls and partitions – where possible functionally**  
Omitting internal walls and partitions wherever open floor plans might be achieved. This may include omitting most internal walls and partitions and including a limited number of modularized or flexible partitions that can be moved within a space to fit varying needs.

### Procuring

- **Build less**  
Procuring building materials with longer lifespans is of relevance to space plan elements due to their shorter overall lifespans, as is aligning with design for disassembly/ replacement concepts. Note that this technically relates to operational replacement embodied (B4) emissions but due to the lifespans in question it is worth noting because the long-term savings will likely outweigh those made to the upfront embodied carbon from material choices. In this instance, the responsibility lies with the consumer (i.e., the tenants) to choose materials with longer lifespans and to opt not to replace space plan elements only in order to keep up with architectural trends.
- **Reuse**  
Procure the raised floors and suspended ceilings from material banks (e.g., old buildings) using circular principles. However, these

circular markets are currently underdeveloped and require significant maturing to function at scale. These measures require early design integration. Further opportunities to remove embodied carbon in the space plan come from primary material choices and recycled content.

- **Recycle**

Procuring recycled carpet, plasterboard (for wall and ceiling finishes), kitchen tops and floor panels.

### Low carbon space plan finish materials

Some examples are:

- Linoleum as an alternative to vinyl
- Water-based eco paints (e.g., limewash)
- Cork as an internal finish for walls and ceilings
- Bamboo for flooring
- Timber (misc. uses)
- Clay plasters as alternative to gypsum equivalents

**Figure 85:** Examples of exposed ceiling (no suspended ceiling) versus typical demountable suspended ceiling



## Emerging low-carbon examples

### Raised floors

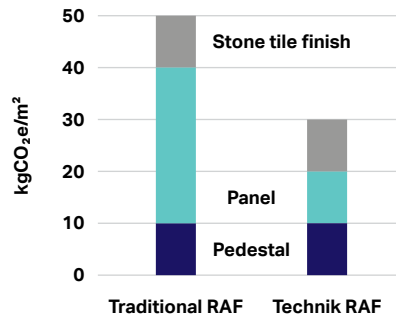
As highlighted above, raised floors often contribute the largest proportion of the upfront embodied emissions within the space plan. Using recycled and low-carbon componentry within the system can significantly reduce carbon impact.

The example in figure 86 uses recycled substrate floor panels, consisting of up to 95% calcium sulphate and recycled paper supported by steel pedestals to form a raised floor system. In comparison with some more traditional flooring systems, which have an estimated upfront embodied carbon intensity of typically about 50 kg CO<sub>2</sub>e/m<sup>2</sup>, the flooring system has an intensity of 30 kg CO<sub>2</sub>e/m<sup>2</sup>.

### Internal walls and partitions

There is a lot of potential in the market for emerging products, such those examples included below, to replace existing, more

Figure 86: Technik flooring system with half tile finish



carbon-intensive metal and cement-based products with alternatives that are much lower in terms of their embodied carbon content and even have the potential to store or sequester carbon.

It is worth noting that companies should assess each building or refurbishment for material selection on an individual basis,

in that the examples outlined below will not always be the most low-carbon option when compared with using, for example, plasterboard drywall with a high gypsum recycled content. In addition, there is the question of whether some of these alternatives can achieve the scale needed to address global demand in the short time frames required.



Arup – 80 Charlotte Street

## Internal walls

**Hempcrete** is a non-structural, composite material made by mixing hemp shiv (the woody inner portion of the hemp stalk) with a wet lime binder. It provides a natural, vapor permeable insulation material that can be used in various forms in internal walls and flooring.

**Earth bricks and blocks** (i.e., adobe) have been used for as long as humankind has been building. At their crudest, these materials are hand molded from clay rich soils and dried in the sun. It is possible to improve structural performance by mechanically pressing or extruding the materials

and stabilizing with a cement or hydraulic lime. Typically used in non-load bearing internal partition walls, they are a low-carbon alternative to concrete blocks or timber/metal stud walls. They also help regulate heat through their high thermal mass. Additionally, it is possible to reinforce earth bricks and blocks with natural fibers such as straw (e.g., "strock" or hemp shiv.) to create composite blocks.

Clay rich soils and aggregates can be compressed by hand or hydraulic rams into shuttering to create **rammed earth**. Rammed earth has been used for thousands of years and more recently as a popular low-carbon alternative to

cast concrete. Cob (compressed clay and straw) is another traditional walling method that has been used globally for centuries that is gaining popularity as a low-carbon alternative.

Conventional **straw bales** can be connected with steel or timber spiked rods to produce masonry infill walls, of which the durability and fire performance can be improved with lime renders (external), clay plasters (internal) or rainscreen cladding such as timber weatherboards. These are available as prefabricated timber cassette panels.

Figure 87: Example of hempcrete wall



Figure 88: Example of adobe brick



Figure 89: Example of rammed earth structure



Figure 90: Example of straw bale modules



## Partitions

Conventional **straw bales** can be connected with steel or timber spiked rods to produce masonry infill walls, of which the durability and fire performance can be improved with lime renders (external), clay plasters (internal) or rainscreen cladding such as timber weatherboards. These are available as prefabricated timber cassette panels.

Some lower carbon new alternatives to gypsum, cementitious based partitions are beginning to emerge.

Compressed straw boards, manufactured by placing straw under heat and pressure creates a reaction in the natural resins within the straw that binds the materials together. The materials are bound at the edges with paper to create a board material that can be used for several applications, such as internal partitions. Other bio-material bi-products such as rice husks, an agricultural bi-product, can be used in a similar manner.

**Hemp**, a rapid growth biomaterial can be formed into corrugated sheet via the use of farm bio-waste resin to form rigid corrugated sheets.

**Mycelium**, the vegetive filament root structure of mushrooms, again a waste byproduct, is also starting to be used in a similar capacity.

It is also possible to replace gypsum-based plasters with emerging **clay-based alternatives** to further lower the embodied carbon of internal partitions.

Figure 91: Example of compressed straw boards



Figure 92: Example of rice husk ash bricks



Figure 93: Example of hemp corrugated sheet



Figure 94: Example of mycelium building blocks



## 4 – Services

Figure 95: Services – Estimated typical distribution of upfront embodied carbon (A1-A5)

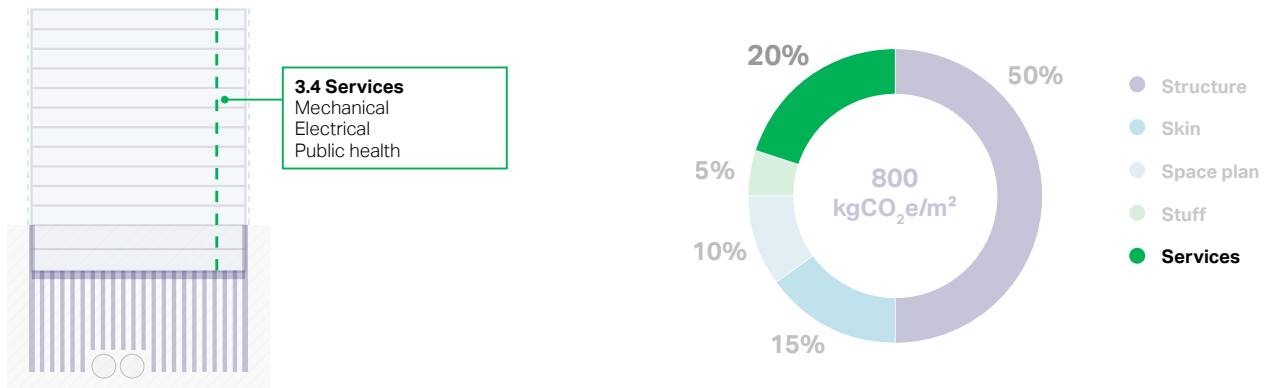
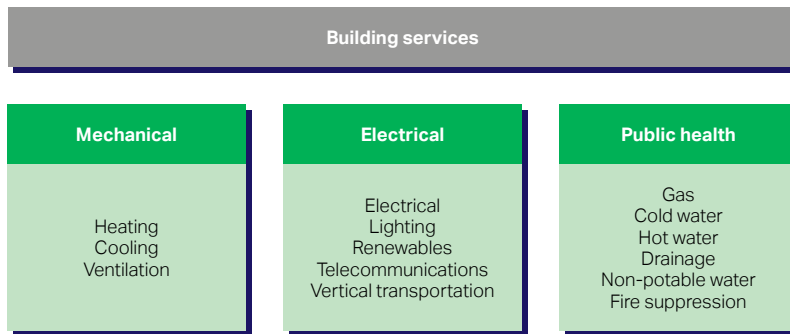


Figure 96: Building services systems



### How do we halve construction emissions?

The results across the six case studies we previously explored in **Where do we stand?** show that 75% of the emissions associated with the services layer are related to the operational energy consumed during the lifetime of the building (B6 Operational Energy Use). However, it is important to note the relative contributions of embodied and operational carbon vary depending on building type and energy source. As the grid decarbonizes and companies switch to all-electric buildings, embodied carbon will represent

a higher portion of the whole life carbon of the services layer, demanding attention now. It is essential that design decisions be made in a holistic way, following a whole life carbon approach to consider both operational and embodied carbon impacts.

According to several available sources,<sup>24,25</sup> building services can represent 4-16% of total upfront (A1-A5) embodied carbon emissions for residential buildings, 15-20% for commercial buildings and 11-13% for schools.

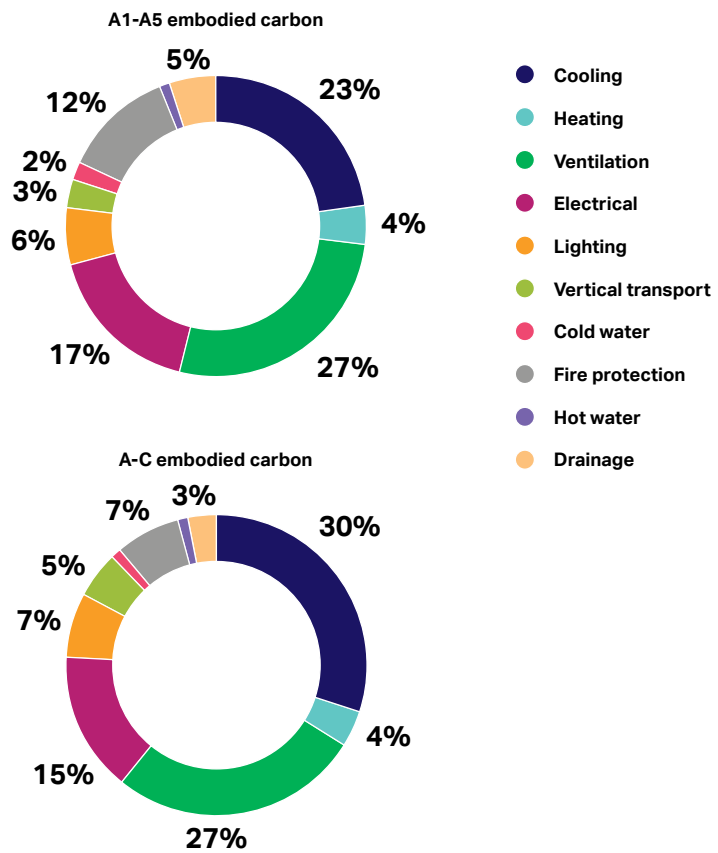
Figure 97 illustrates how the embodied carbon of the services layer is split into the different mechanical, electrical and plumbing systems for an Arup commercial case study in London. Note the difference between the contribution of cooling to A1-A5 embodied carbon (23%) and to A-C (30%). This is primarily due to the impact of refrigerant leakage in cooling systems, which is captured in stage B1.

**Taking a whole life carbon approach to reduce the impact of services**

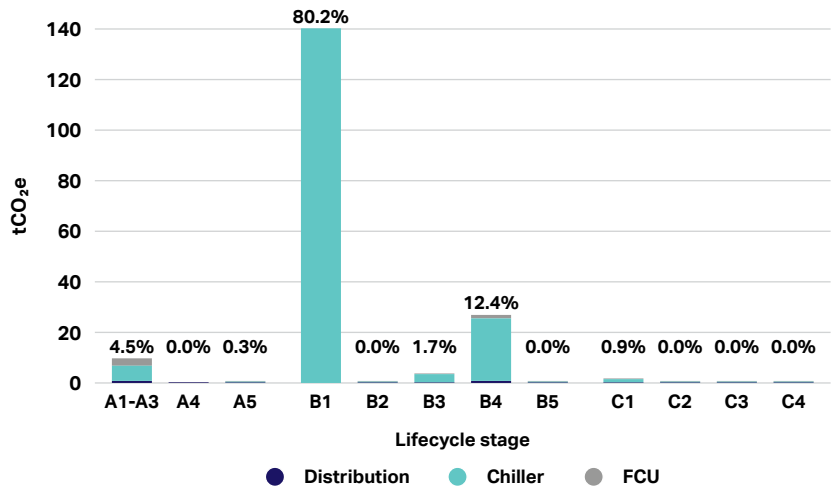
As with other building layers, designers should consider carbon as a key parameter throughout the development of a building project, from the earliest opportunity. Although the focus of this report is A1-A5 upfront embodied carbon, B1 which captures the impact of refrigerant leakage and B4 which captures equipment replacement should not be ignored (see figure 98). As illustrated in our previous report, **Where do we Stand?** case studies, when considering A-C whole-life embodied carbon, the services layer can represent as much as 30% of the building’s total embodied carbon, only marginally less than the structural layer.

**The services layer contributes significantly to a building’s whole life carbon emissions, so it is necessary to look holistically at how companies can make significant reductions in an effective way.**

**Figure 97:** Embodied carbon contribution of building services systems to A1-A5 and A-C, based on an Arup case study for a newly built, mid-rise office building in London



**Figure 98:** Embodied carbon of a mechanical cooling system illustrating the high contribution of refrigerant (R410A) leakage in B1 and equipment replacement in B4 to A-C embodied carbon



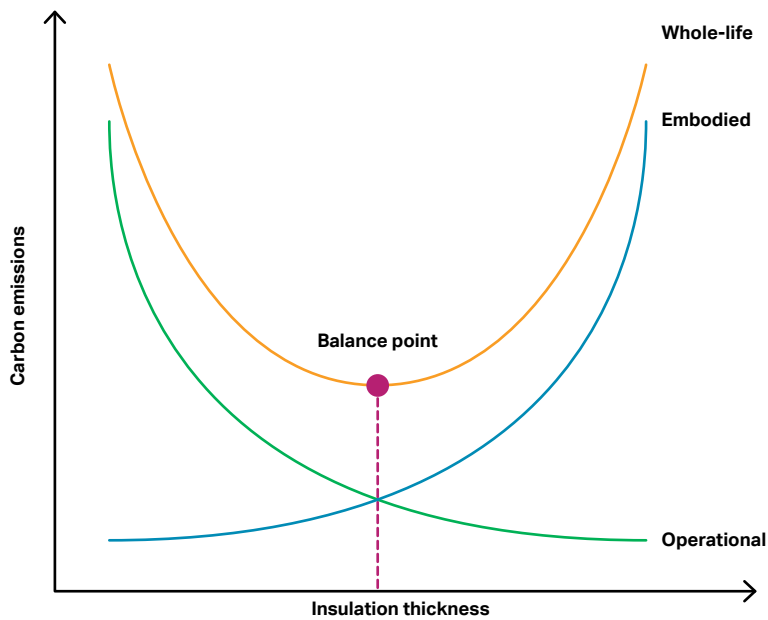
Companies need to be careful not to shift emissions from one whole life carbon stage to another or from one layer to another, so that the decisions designers make lead to the most significant carbon reductions overall.

For design decisions where there might be a compromise between embodied and operational carbon, companies should look for the whole life-cycle **balance point** as illustrated in Figure 99.

For example, as companies increase insulation thickness to improve façade performance and thus reduce operational carbon (in green), they increase the embodied carbon by adding more material (in blue). If companies increase insulation thickness beyond the balance point, the embodied carbon cost becomes higher than the operational carbon saving. Therefore, companies must consider where the balance point lies to optimize whole life

carbon. The balance point will vary depending on the building and type of intervention, so it is necessary to evaluate it on a case-by-case basis. When assessing these design options, it is also important that companies look beyond whole life carbon, keeping in mind other factors such as the impact on energy use intensity and building running costs.

**Figure 99:** Whole life carbon balance points. Example on wall insulation thickness.





### Embodied carbon hotspots

Calculating the embodied carbon of building services systems is complex due to the high number of components making up each system and the limited data available from manufacturers. Enabling the identification of the biggest contributors to embodied carbon will require wider manufacturer and industry engagement. The rapid development of standardized

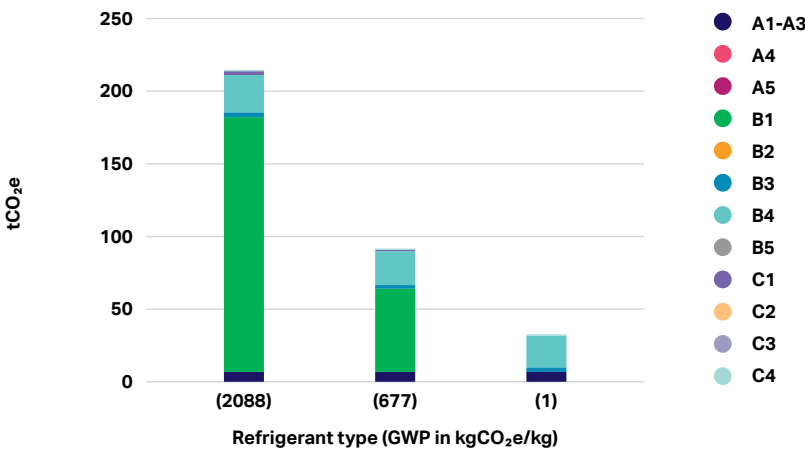
carbon intensity data, such as internationally accredited **environmental product declarations (EPDs)** or **CIBSE TM65<sup>26</sup>** forms as a minimum, is essential.

Some key opportunity areas to reduce embodied carbon impacts are starting to emerge.

**Refrigerants** within chillers, heat pumps or other heating and cooling equipment:

Figure 100 illustrates the impact of switching R410A refrigerant with R32 and R1234ze on the embodied carbon of a 100kW air cooled chiller. The study assumed the same chiller can use all three refrigerants. In practice, there are other considerations (such as efficiency, flammability, etc.) when selecting heating and cooling equipment but companies must strive to reduce refrigerant charge and select low GWP refrigerants.

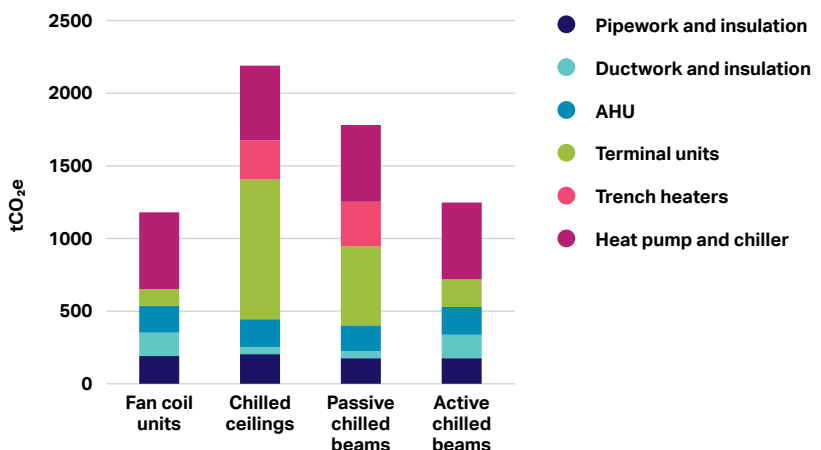
**Figure 100:** Embodied carbon of a 100kW air cooled chiller using different refrigerants; R410A, R32 and R1234ze



### Distribution

Distribution accounts for a significant portion of services A-C embodied carbon and should be considered alongside primary plant. Figure 101 shows data from an Arup study that compares the embodied carbon of several HVAC strategies. Results highlight the high contribution of pipework and ductwork to the overall embodied carbon of all HVAC systems assessed.

**Figure 101:** A-C embodied carbon contribution of pipework and ductwork to HVAC systems, based on an Arup case study for a newly built, mid-rise office building in London



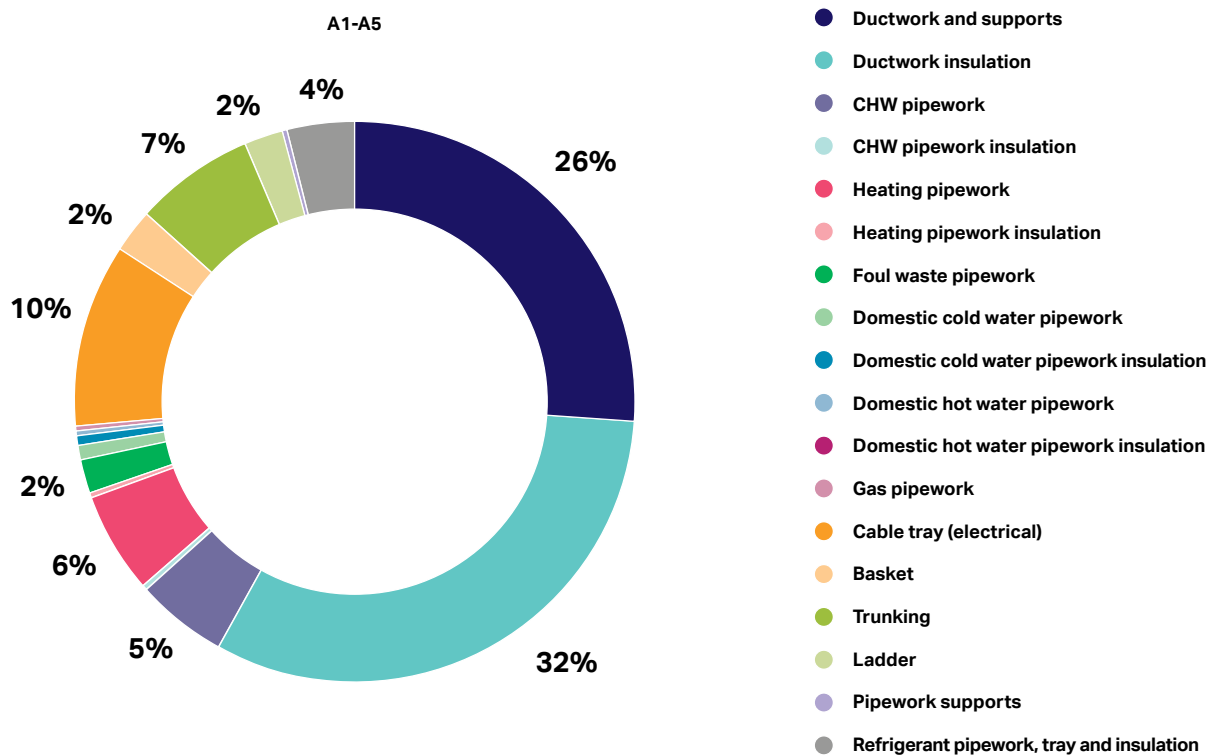
An Arup study looking at six commercial buildings found the embodied carbon of distribution to range from 25 to 70 kgCO<sub>2</sub>e/m<sup>2</sup> depending on the services density. Figure 102 shows the embodied carbon contribution of the various components. This study highlighted the notable contribution of ductwork and associated insulation to the embodied carbon of distribution,

both for A1-A5 and A-C embodied carbon. Note: Arup excluded cables from this particular study but they could contribute significantly to the embodied carbon of distribution.

To minimize the impact of services distribution, companies should consider choosing systems that reduce the need for distribution and ensure distribution routes are efficient. Companies should avoid

oversizing distribution systems and challenge outdated sizing guidance. Companies can also consider specifying low embodied carbon materials such as textile or cardboard ductwork and as a minimum, materials with a high recycled content. In addition, designing for deconstruction will enable reuse and recycling at end of life.

**Figure 102:** Embodied carbon of MEP distribution components (excluding cabling), based on an Arup study of six commercial buildings in the UK



**Figure 103:** Example of cradle-to-cradle certified textile ductwork, Cradle Vent, used in a health center



**Figure 104:** Example of cardboard ductwork, Gatorduct, used in an office environment



## Photovoltaic panels (PV)

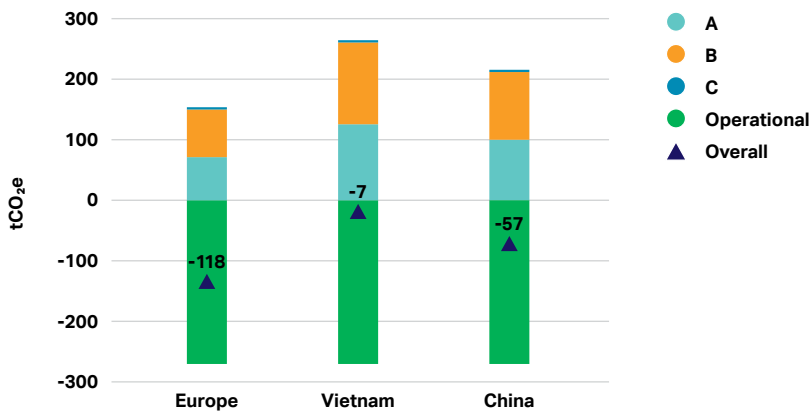
PV can play a major role in reducing the operational carbon of a building but the embodied carbon expenditure may not always offset the savings achieved. However, even if the PV does not result in carbon savings for the building, it may provide a positive contribution to the decarbonization of the grid and can alleviate pressure on the existing electricity infrastructure. It is worth noting that because the grid carbon factor does not

typically include the embodied carbon of grid electricity infrastructure, calculating the WLC of PV can look less favorable. In using PVs well, companies should aim to gain an understanding of what they are contributing from the widest possible perspective.

One factor that can have a large impact on the embodied carbon of PV is the country of manufacture. For an Arup residential case study in London, figure 105 shows that panels manufactured in China

and Vietnam produce ~40% and ~73% more A-C embodied carbon emissions respectively than a panel manufactured in Europe. This means that the carbon payback for these modules would be much longer than for a panel produced in Europe. As the use of PV increases globally and waste management improves, enabling higher rates of recycling of materials, the embodied carbon of PV will reduce.

**Figure 105:** Whole life carbon emissions related to the installation of 444 m<sup>2</sup> of PV panels for different countries of manufacture



### General principles for the reduction of services embodied carbon

While we collect better data and carry out more research to inform decisions for the embodied carbon of the services layer, there are already strategies companies can focus on to make significant reductions.

#### Build less

- **Build fewer systems with fewer components.** For example, remove hot water provision to public toilets.
- **Reduce the size of central plants;** employ a fabric-first approach to minimize thermal demand; challenge the brief on criteria such as acceptable internal temperatures.
- **Reduce refrigerant charge** of heating and cooling systems. For example, consider the compressor type selected.
- **Replace less often and maximize the life of components** by improving access and implementing good maintenance regimes, therefore increasing equipment lifespans.
- **Compare centralized and decentralized systems;** investigate trade-offs between plant and distribution embodied carbon.
- **Optimize distribution routes** to reduce material use.
- **Do not consider services in isolation;** evaluate whether a choice of system requires additional strengthening of the structure or the installation of false ceilings and raised access floors.

Figure 106: Example of exposed services in 80 Charlotte Street, London



Jack Hobhouse – 80 Charlotte Street

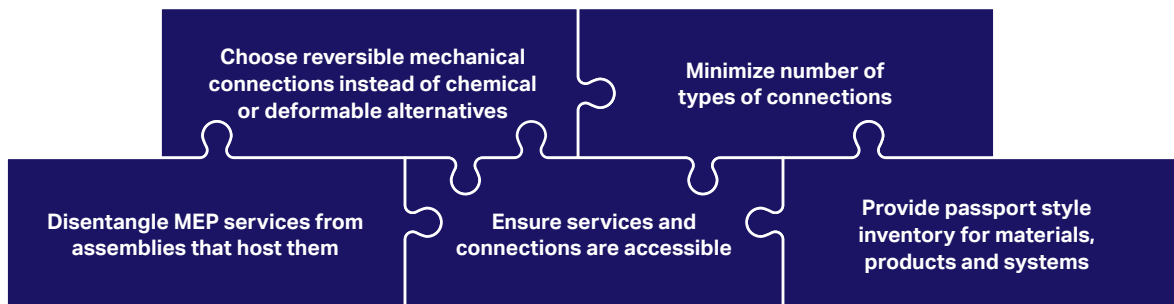
**Build clever**

- **Adopt a circular economy approach<sup>27</sup>**
- **Reduce refrigerant impact;** specify low global warming potential (GWP) refrigerants and consider how to reduce leakage rates during operation (by avoiding on-site refrigerant management), maintenance and end of life.
- **Specify building services as a service.** Example manufacturers include Signify for lighting, Kaer for cooling and Mitsubishi electric for vertical transportation.<sup>28,29</sup>

- **Prioritize low embodied carbon and recycled materials.** Examples include textile or cardboard ductwork.
- **It is not always about less stuff.** Passive systems like chilled ceilings and passive chilled beams have a lower heat transfer coefficient so more material may be needed to achieve the same performance.
- **Be clever about enabling flexibility;** “long life, loose fit”.
- **Consider cradle-to-cradle certified<sup>30</sup> products:** emerging global standards for products that are safe, circular and responsibly made.

- **Reduce the size of central plant** by looking for opportunities to optimize free cooling and use waste heat.
- **Design for deconstruction** to enable reuse at the end of life (refer to figure 107).
- **Collaborate between disciplines** to reduce the amount of equipment required and maximize efficiencies.

**Figure 107:** Key building services principles to design for deconstruction



Arup – Television Centre

**Build efficiently and minimize waste**

- **Reuse and refurbish existing buildings services systems** where possible.
- **Consider prefabrication** to minimize waste and reduce on site construction activities. Examples include packaged plantrooms and bathroom pods as shown in Figure 108.

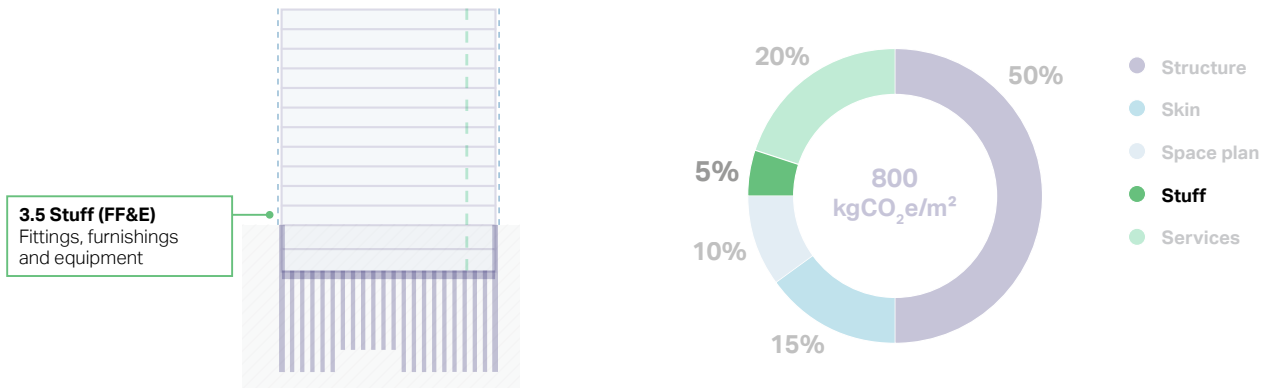
**Figure 108:** Example of prefabricated bathroom pod



PIVOTek – Bathroom Pod

## 5 – Stuff

**Figure 109:** Stuff – Estimated typical distribution of upfront embodied carbon (A1-A5)

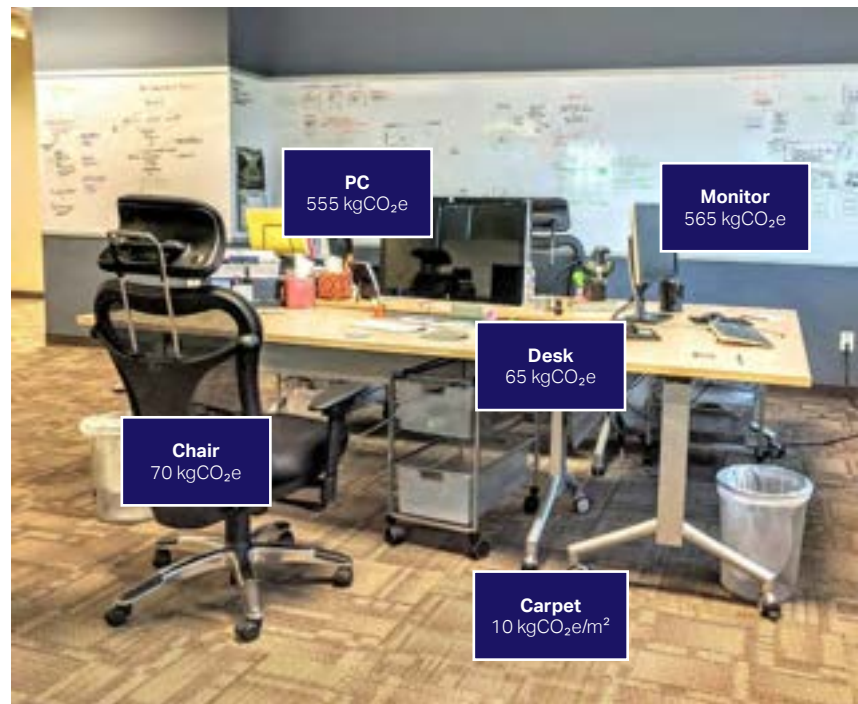


The stuff building layer consists of the fittings, furnishings and equipment (FF&E) that are placed in buildings and generate emissions during the product and construction (A) stage and during the operational (B) stage through upgrades and replacement.

Elements within the stuff layer are currently outside of the scope of this report due to the lack of available material to support reasonable conclusions. These elements are often not considered in the current life-cycle assessments which form the basis of the evidence base for this report.

The impact associated with Stuff is potentially very variable depending on building use, and is also likely dominated by the operational stage (B) replacement cycles, which again can vary significantly. Given this variability we recommend a detailed specific study on the whole-life carbon impact of the Stuff building layer be undertaken as part of the WBCSD Net-zero buildings programme.

**Figure 110:** Typical accumulated carbon footprint of a workstation set up over 60-year lifetime



**Workstation, 60-year lifecycle. PC, monitor, desk and chair replaced every 5 years. Carpet replaced every 10 years.**



# ④ Conclusion

Immediate, systemic decarbonization of the built environment is essential to stay within the emissions limits associated with the Intergovernmental Panel on Climate Change 1.5°C scenario and begin to contain the effects of climate change. Without the major reductions contribution of the built environment, the necessary global decarbonization pathways will simply not be achievable.

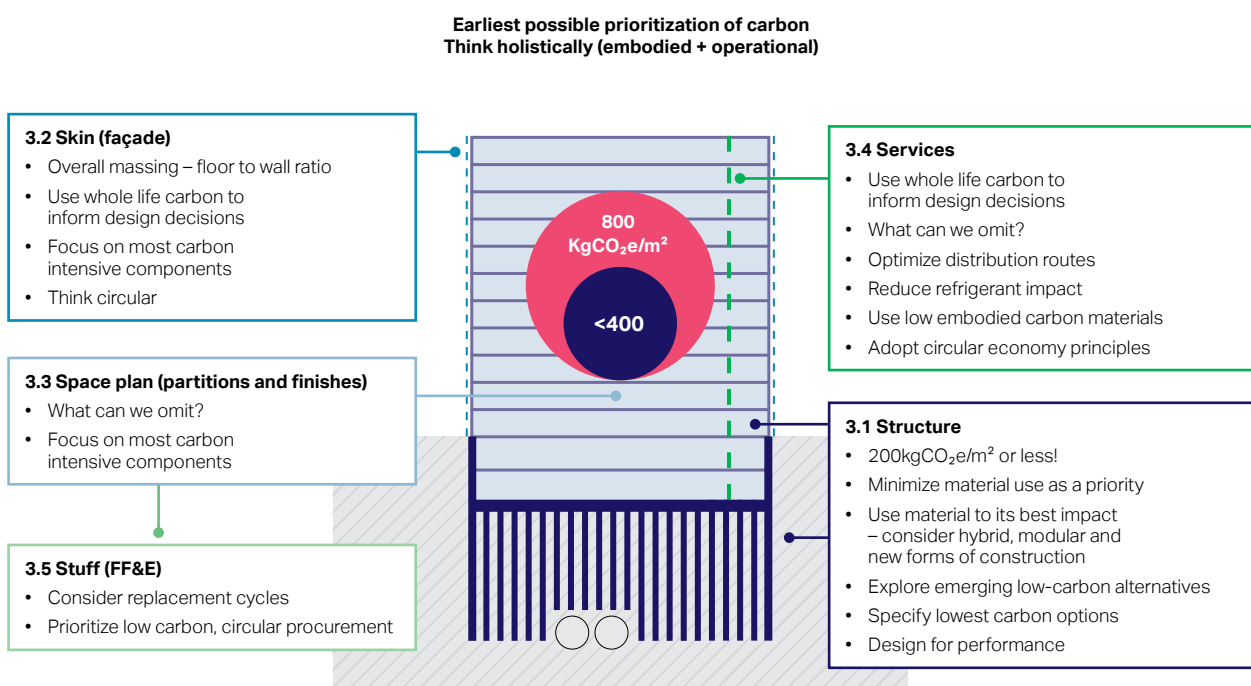
The scale of the problem is now clear and points to a halving of current levels of emissions by 2030 to facilitate the necessary global reductions. Projects that will be delivered in and beyond 2030 are being conceived and on the drawing boards now. Hence, **for the built environment, 2030 is today.**

The problem being clear, companies must now rapidly pivot to the solution, **how** they are going to achieve this immediate, systemic reduction. The information contained in this report is not meant to be definitive but point to opportunities toward an overall systemic reduction. The conclusion drawn is that there is **no single solution** to the problem but that companies now need to think about all the decisions companies make from the earliest stage of building projects with a clear and informed focus on carbon reduction. Companies must be better informed as to the strategies that they might deploy and the interaction of different decisions across the entire whole life carbon outcome.

Companies must work collaboratively across the whole built environment value chain to drive down consumption demand while simultaneously looking to reduce carbon intensity on the supply side.

We summarize below some of the key conclusions of this report across the building layers of the WBCSD framework.

Figure 111: Summary diagram of key focus areas



## Whole building

Carbon reduction needs to be clearly prioritized and considered in all decisions from the earliest point of the project. Companies need to appraise the highest impact decisions, such as whether to repurpose an existing building or build new, overall massing and orientation, height, a whole life carbon perspective and frame the best overall low-carbon strategy from the outset.

Companies should consider carbon in the context of performance-based design, whereby they move away from overly prescriptive and conservative norms toward honed and specific outcomes. In line with this, companies should consider systemizing more of the built environment solutions in order to hone them from a carbon perspective in a factory environment, using mass production to minimize carbon and waste.

## Structure

The embodied carbon within structures is rapidly becoming better understood, with the establishing of a growing and accessible database of benchmarks. Companies should use this understanding to confidently determine clear targets for all future structural designs. Given the adoption of some of the strategies pointed to in this report, companies should be able to immediately set targets in the range of  $200 \text{ kgCO}_2\text{e/m}^2$  or less, which would constitute a major move toward aligning with 2030 objectives.

In line with the whole building considerations above, companies should plan from the start, considering the major impacts of column grids and basement depth at the outset. A genuine global carbon reduction understanding and interest should drive material choices. Companies should use timber, globally a limited

resource, when and where it is best suited and use the currently limited global supply of cement replacement and recycled steel only when they have done their genuine best to reduce the overall material consumption as a priority. Companies should also consider new hybrid alternatives to established construction techniques, as well as the adoption of systemized manufacturing.

## Skin

Once again, early informed decisions on key planning considerations can have a major impact. The wall-to-floor ratio established in massing the building form, coupled with decisions relating to the glazed-to-solid-wall ratio, can have a major impact in relation to the overall embodied carbon of the skin proportion of the whole life carbon footprint.



Jason Garcia – Atrio Bogotá

Companies must consider the skin or façade system holistically in relation to the carbon payback period associated with balancing decisions about solar, insulation performance with embodied carbon demand.

In reducing embodied carbon, companies must clearly understand the key carbon-intensive components, with the metal frame and glazing typically accounting for around 70% of the total embodied carbon and most of the rest applying to external finishes.

Companies must, where possible, also look to the reuse and repurposing of existing systems and designing new systems to be repurposed in a circular way, prolonging lifespans and negating the need for additional life-cycle carbon expenditure as façades are upgraded in the future.

### Space plan

Most of the impact companies can have related to space plan embodied carbon is associated with decisions related to ceiling and floor finishes. Reducing first

the material necessity for these elements and, where not possible, focusing on minimizing the carbon intensity of the key components can contribute to an overall carbon reduction.

As for other building layers historically replaced during the life cycle, focusing on circular design can also significantly reduce the whole life carbon of the unavoidable elements of the space plan.

### Services

Over a typical building life cycle the services can represent as much as 30% of whole life-cycle embodied carbon. In reducing this, companies must consider embodied carbon and operational carbon holistically from the outset, for the duration of the building's life. Companies need to optimize distribution routes to reduce material use. They should reduce refrigerant impact by specifying low global warming potential refrigerants and reducing refrigerant charge. Companies must prioritize low embodied carbon materials for distribution systems and adopt a circular

economy approach throughout designs.

### Stuff

We have not explicitly covered the topic of stuff within buildings as part of this report as it is a complex, typology specific concern and our earlier report shows it has a limited impact on the initial upfront embodied carbon within buildings. However, it is of concern and companies should aim to understand the topic of stuff better, especially in the context of building types and uses where the stuff within the building is replaced on a frequent basis.

In conclusion, by amalgamating the points above into the earliest holistic whole life carbon strategy for all projects and then collaborating to deliver this, we believe the answer to the question of **"How do we halve construction emissions?"** can be created for all future projects. To deliver this, however, the industry must prioritize carbon outcomes to ambitious levels immediately and then commit together to their delivery.



# Endnotes

- <sup>1</sup> World Business Council for Sustainable Development (WBCSD) (2020). Net-zero buildings: Where do we stand? Retrieved from: <https://www.wbcasd.org/Programs/Cities-and-Mobility/Sustainable-Cities/Transforming-the-Built-Environment/Decarbonization/Resources/Net-zero-buildings-Where-do-we-stand>.
- <sup>2</sup> United Nations (2021), The Paris Agreement. Retrieved from: <https://unfccc.int/process-and-meetings/the-paris-agreement/the-paris-agreement>.
- <sup>3</sup> United Nations Climate Change (2021). "Human Settlements - Climate Action Pathway 2021". Retrieved from: <https://unfccc.int/climate-action/marrakech-partnership/reporting-tracking/pathways/human-settlements-climate-action-pathway>.
- <sup>4</sup> World Green Building Council (2019), Bringing embodied carbon upfront: Coordinated action for the building and construction sector to tackle embodied carbon. Retrieved from: <https://www.worldgbc.org/embodied-carbon>.
- <sup>5</sup> Global Alliance for Buildings and Construction (2021). Global Status Report for Buildings and Construction. Retrieved from: <https://globalabc.org/resources/publications/2021-global-status-report-buildings-and-construction>.
- <sup>6</sup> Intergovernmental Panel on Climate Change (IPCC) (2021). Climate Change 2021: The Physical Science Basis. Contribution of Working Group I to the Sixth Assessment Report of the Intergovernmental Panel on Climate Change. Retrieved from: <https://www.ipcc.ch/report/ar6/wg1/>.
- <sup>7</sup> Laudes Foundation, Aalborg University, Ramboll (2022). Towards embodied carbon benchmarks for buildings in Europe. Retrieved from: <https://c.ramboll.com/lets-reduce-embodied-carbon>.
- <sup>8</sup> World Business Council for Sustainable Development (WBCSD) (2020). The Building System Carbon Framework. Retrieved from: <https://www.wbcasd.org/Programs/Cities-and-Mobility/Sustainable-Cities/Transforming-the-Built-Environment/Decarbonization/Resources/The-Building-System-Carbon-Framework>.
- <sup>9</sup> One Click LCA (2021). Embodied carbon benchmarks for European buildings. Retrieved from: <https://www.oneclicklca.com/eu-embodied-carbon-benchmarks/>.
- <sup>10</sup> London Energy Transformation Initiative (LETI) (2021). Embodied Carbon Target Alignment. Retrieved from: <https://www.leti.london/files/ugd/252d09a45059c2d71043cdbcf539f942e602.pdf>.
- <sup>11</sup> Carbon Leadership Forum (CLF) (2020), Zero Carbon Standard 1.0: A Visionary Path to a Carbon-Positive Future. Retrieved from: <https://living-future.org/zero-carbon/zero-carbon-certification/>.
- <sup>12</sup> Arnold, W., Cook, M., Cox, D., Gibbons, O. & Orr, J. (2020). Setting carbon targets: an introduction to the proposed SCORS rating scheme. Institution of Structural Engineers (UK). Retrieved from: [https://www.istructe.org/journal/volumes/volume-98-\(2020\)/issue-10/setting-carbon-targets-an-introduction-to-scors/](https://www.istructe.org/journal/volumes/volume-98-(2020)/issue-10/setting-carbon-targets-an-introduction-to-scors/).
- <sup>13</sup> International Energy Agency (IEA) (2021). Cement. IEA: Paris. Retrieved from: <https://www.iea.org/reports/cement>.
- <sup>14</sup> International Energy Agency (IEA) (2021). Iron and Steel. IEA: Paris. Retrieved from: <https://www.iea.org/reports/iron-and-steel>.
- <sup>15</sup> International Rebar Producers and Exporters Association (IREPAS) (2022). Outlook. Retrieved from: <http://www.irepas.com/?tag=outlook>.
- <sup>16</sup> FAO of the United Nations "Global Forest Products Facts and Figures" (2018). Retrieved from: <https://www.fao.org/3/ca7415en/ca7415en.pdf>.
- <sup>17</sup> Mineral Products Association (MPA), The Concrete Centre (2009). Economic Concrete Frame Elements to Eurocode 2. CCIP 025.
- <sup>18</sup> United Nations Environment (2017). Eco-efficient Cements: Potential Economically Viable Solutions for a Low-CO2 Cement-based Materials Industry. Retrieved from: <https://wedocs.unep.org/20.500.11822/25281>.
- <sup>19</sup> Global Cement and Concrete Association (GCCA) (n.d.). "Getting to Net Zero". Retrieved from: <https://gccassociation.org/concretefuture/getting-to-net-zero/>.
- <sup>20</sup> UK CARES [2020] EPD.
- <sup>21</sup> Circlar Ecology (2019) The Inventory of Carbon and Energy (ICE) Database. Retrieved from: <https://circularecology.com/embodied-carbon-footprint-database.html>.
- <sup>22</sup> Hawkins, W. (2021). Timber and carbon sequestration. The Institution of Structural Engineers. Retrieved from: [https://www.istructe.org/journal/volumes/volume-99-\(2021\)/issue-1/timber-and-carbon-sequestration/](https://www.istructe.org/journal/volumes/volume-99-(2021)/issue-1/timber-and-carbon-sequestration/).
- <sup>23</sup> Arup and Saint-Gobain (2022). Carbon footprint of facades: significance of glass. Retrieved from: <https://www.arup.com/perspectives/publications/research/section/carbon-footprint-of-facades-significance-of-glass>.
- <sup>24</sup> London Energy Transformation Initiative (LETI) (2020). Embodied Carbon Primer. Retrieved from: [https://www.leti.uk/files/ugd/252d09\\_8ceffcbcafdb43cf8a19ab9af5073b92.pdf](https://www.leti.uk/files/ugd/252d09_8ceffcbcafdb43cf8a19ab9af5073b92.pdf).
- <sup>25</sup> Mayor of London (2022). London Plan Guidance – Whole Life-Cycle Carbon Assessments. Retrieved from: [https://www.london.gov.uk/sites/default/files/lpg\\_-\\_wlca\\_guidance.pdf](https://www.london.gov.uk/sites/default/files/lpg_-_wlca_guidance.pdf).
- <sup>26</sup> CIBSE "TM65 Embodied carbon in building services: A calculation methodology (2021)". Retrieved from: <https://www.cibse.org/knowledge-research/knowledge-portal/embodied-carbon-in-building-services-a-calculation-methodology-tm65>.

<sup>27</sup>Chartered Institution of Building Services Engineers (CIBSE) (2020). Research Insight 02: Circular economy principles for building services. Retrieved from: <https://www.cibse.org/knowledge-research/knowledge-portal/research-insight-02-circular-economy-principles-for-building-services>.

<sup>28</sup>UK Green Building Council (UKGBC) (2020). Circular Economy Implementation Packs for Products as a Service and Reuse. Retrieved from: <https://www.ukgbc.org/ukgbc-work/circular-economy-implementation-packs/>.

<sup>29</sup>Basel Agency for Sustainable Energy (BASE) and Clean Cooling Collaborative (n.d.). "Cooling as a Service (CaaS) Initiative". Accessible on: <https://www.caas-initiative.org/>.

<sup>30</sup>Cradle to Cradle Products Innovation Institute (n.d.). "Cradle to Cradle Certified". Retrieved from: <https://www.c2ccertified.org/get-certified/product-certification>.

Orr, J.J., Cooke, M., Ibell, T.J., Smith, C. & Watson N. (2021) Design for zero. Institution of Structural Engineers (UK). Retrieved from: <https://www.istructe.org/resources/guidance/design-for-zero/>.

How to calculate the embodied carbon of facades: A methodology. September 2022. Centre for Window and Cladding Technology. Retrieved from: <https://www.cwct.co.uk/products/how-to-calculate-the-embodied-carbon-of-facades-a-methodology>.

## ACKNOWLEDGMENTS

The Net-zero buildings Halving construction emissions today (2022) publication was prepared by Arup in collaboration with WBCSD. The primary contributors of this publication are as follows:

### Arup

**Chris Carroll**

Director, Building Engineering

**Daniel Bevan**

Scientist, Climate and Sustainability

**Fernando Ruiz**

Associate, Façade Design

**Sarah Bousquet**

Engineer, Building Services

**Rowan Bell-Bentley**

Engineer, Building Services

**Maria Benazzo**

Engineer, Building Services

**Yolande Alves de Souza**

Engineer, Building Engineering

**Daniel Silva**

Designer, Visual Communications

### WBCSD

**Roland Hunziker**

Director, Built Environment

**Luca De Giovanetti**

Senior Manager, Built Environment

**Veronica Contucci**

Associate, Built Environment

**Victoria Falcone**

Intern, Built Environment

## DISCLAIMER

This report is released in the name of WBCSD. Like other WBCSD publications, it is the result of collaborative efforts by members of the secretariat and executives from member companies. It does not mean, however, that every member company agrees with every word.

## ABOUT ARUP

Arup is a professional consultancy providing services in management, planning, design and engineering. As a global firm we draw on the skills of nearly 17,000 consultants across the world; our reputation in striving to continually develop innovative tools and techniques means that we have the people, processes and systems to deliver holistic solutions for clients.

Our work is shaped by our mission statement, to Shape a Better World, and in 2020 we revised our Global Strategy to put sustainable development at the heart of everything we do. Arup has committed to achieving net-zero emissions across its entire operations by 2030, covering everything from the energy used in offices to goods and services purchased. To achieve this the firm has set a target to reduce its scope 1, 2 and 3 global greenhouse gas (GHG) emissions by 30% by 2025 from a 2018 baseline.

We were founding signatories of UK Architects Declare Climate and Biodiversity Emergency and UK Engineers Declare Climate and Biodiversity Emergency.

### Arup

8 Fitzroy Street  
London  
W1T 4BJ  
United Kingdom

[www.arup.com](http://www.arup.com)

## ABOUT WBCSD

WBCSD is the premier global, CEO-led community of over 200 of the world's leading sustainable businesses working collectively to accelerate the system transformations needed for a net zero, nature positive, and more equitable future.

We do this by engaging executives and sustainability leaders from business and elsewhere to share practical insights on the obstacles and opportunities we currently face in tackling the integrated climate, nature and inequality sustainability challenge; by co-developing "how-to" CEO-guides from these insights; by providing science-based target guidance including standards and protocols; and by developing tools and platforms to help leading businesses in sustainability drive integrated actions to tackle climate, nature and inequality challenges across sectors and geographical regions.

Our member companies come from all business sectors and all major economies, representing a combined revenue of more than USD \$8.5 trillion and 19 million employees. Our global network of almost 70 national business councils gives our members unparalleled reach across the globe. Since 1995, WBCSD has been uniquely positioned to work with member companies along and across value chains to deliver impactful business solutions to the most challenging sustainability issues.

Together, we are the leading voice of business for sustainability, united by our vision of a world where 9+ billion people are living well, within planetary boundaries, by mid-century.

[www.wbcd.org](http://www.wbcd.org)

Follow us on [Twitter](#) and [LinkedIn](#)

### Copyright

© WBCSD, January 2023.

**World Business Council  
for Sustainable Development**

Geneva, Amsterdam, Beijing, New Delhi, London, New York City, Singapore

[www.wbcsd.org](http://www.wbcsd.org)



IQL Pavilion, London © Hufton + Crow